



Science **made** smarter

Instructions for Use – US

# AD629



**Interacoustics**

**Copyright © Interacoustics A/S:** All rights reserved. Information in this document is proprietary to Interacoustics A/S. The information in this document is subject to change without notice. No part of this document may be reproduced or transmitted in any form or by any means without a prior written permission of Interacoustics A/S.

# Table of Contents

<b>1</b>	<b>INTRODUCTION</b>	<b>1</b>
1.1	About this manual	1
1.2	Intended use	1
1.3	Product description	2
1.4	Warning	2
1.5	Complaints/safety reporting:	2
1.6	Disposal of the product	3
<b>2</b>	<b>UNPACKING AND INSTALLATION</b>	<b>4</b>
2.1	Unpacking and Inspection	4
2.2	Marking	5
2.3	General warnings and precautions	6
<b>3</b>	<b>GETTING STARTED - SETUP AND INSTALLATION</b>	<b>8</b>
3.1	Back panel external connections – standard accessories	9
3.2	PC-Interface	9
3.3	Patient communication and monitoring	10
3.3.1	Talk Forward	10
3.3.2	Talk Back	10
3.3.3	Monitoring	10
3.4	Operating instructions	11
3.5	Tests screens and function key descriptions	15
3.5.1	Tone test	16
3.5.2	Stenger Test	16
3.5.3	ABLB - Fowler test	17
3.5.4	Tone in noise test (Langenbeck Test)	17
3.5.5	Weber	18
3.5.6	Speech test	18
3.5.6.1	Speech – CH2On	21
3.5.6.2	Speech in noise	21
3.6	Setup	27
3.6.1	AD629 setup	28
3.6.2	Common settings	28
3.6.3	Tone setting	30
3.6.4	Speech settings	31
3.6.5	Auto settings	32
3.6.6	Sessions and clients	32
3.6.6.1	Save session	33
3.6.6.2	Clients	33
3.7	Printing	34
3.8	AD629 stand alone unit, print logo update	34
3.9	Diagnostic suite	36
3.9.1	AD629 setup	36
3.9.2	SYNC mode	37
3.9.3	The SYNC tab	37
3.9.4	Client upload	38
3.9.5	Session download	38
3.10	Hybrid (online/PC-controlled) mode	40
3.11	About Diagnostic Suite	41
<b>4</b>	<b>MAINTENANCE</b>	<b>42</b>
4.1	General maintenance procedures	42
4.2	How to clean Interacoustics products	43
4.3	Concerning repair	43
4.4	Warranty	44
<b>5</b>	<b>GENERAL TECHNICAL SPECIFICATIONS</b>	<b>45</b>
5.1	AD629 technical specification	45

5.2	Survey of reference and max hearing level tone audiometer.....	50
5.3	AD629 pin assignments.....	61
5.4	Electromagnetic compatibility (EMC).....	62



# 1 Introduction

## 1.1 About this manual

This manual is valid for the AD629 firmware version 1.42. These products are manufactured by:

**Interacoustics A/S**

Audiometer Allé 1

5500 Middelfart

Denmark

Tel.: +45 6371 3555

E-mail: [info@interacoustics.com](mailto:info@interacoustics.com)

Web: [www.interacoustics.com](http://www.interacoustics.com)

## 1.2 Intended use

The AD629 audiometer is designed to be a device for diagnosing hearing loss. Output and specificity of this type of device are based on the test characteristics defined by the user and may vary depending on environmental and operating conditions. The diagnosing of hearing loss using this kind of diagnostic audiometer depends on the interaction with the patient. However, for patients not responding well possibilities of various tests allow the tester to have at least some evaluative result. Thus, a “normal hearing” result should not allow for ignoring other contra indications in this case. A full audiologic evaluation should be administered if concerns about hearing sensitivity persist.

The AD629 audiometer is intended to be used by an audiologist, hearing healthcare professional or trained technician in an extremely quiet environment according to the ISO standard 8253-1. This AD629 is intended for all patient groups regarding sex, age, and health. Careful handling of the AD629 whenever in contact with a patient should be of high priority. Calm and stable positioning while testing is preferred for optimal accuracy.



### 1.3 Product description

The AD629 is a 2 channel clinical audiometer offering air, bone, speech and free field line output. It offers a wide range of clinical test features such as high frequency, SISI, etc.

Included parts	DD45 Audiometric headset <sup>1</sup> B71 Bone conductor <sup>1</sup> APS3 Patient response button <sup>1</sup> Goose neck microphone Power cable Operation manual CD Multilingual CE instructions for use
Optional parts	Diagnostic Suite software OtoAccess® database Carrying case (Standard or Trolley Style) IP30 Audiometric insert phones <sup>1</sup> TDH39 Audiometric headset <sup>1</sup> DD450 Audiometric headset <sup>1</sup> DD65v2 Audiometric headset <sup>1</sup> B81 Bone conductor <sup>1</sup> Talk back microphone Sound field speakers SP90 (with external power amp) AP12 Power Amplifier 2x12 Watt AP70 Power Amplifier 2x70 Watt

### 1.4 Warning

Throughout this manual, the following meaning of warnings, cautions and notices are used:

### 1.5 Complaints/safety reporting:



**WARNING** indicates a hazardous situation which, if not avoided, could result in death or serious injury.



**CAUTION**, used with the safety alert symbol, indicates a hazardous situation which, if not avoided, could result in damage of the equipment.

**NOTICE**

**NOTICE** is used to address practices not related to personal injury or damage of the equipment.

Please contact your local distributor in case of any incident related to product defects (hardware defects or software bugs) or adverse events (which does not necessarily have a causal association to the product). It is recommended for a user to report all the known facts about the incident. Upon receipt of any serious incident with serious health impact for the patient or user (serious adverse events), local distributor shall report to Interacoustics through its appropriate vigilance system. Interacoustics shall ensure that the regulatory authority in patient's home country is informed according to the vigilance requirements. Interacoustics shall handle all the product complaints and adverse events as per the internal procedure.

1) Applied parts according to IEC60601-1



## **1.6 Disposal of the product**

Interacoustics is committed to ensuring that our products are safely disposed of when they are no longer usable. The cooperation of the user is important to ensure this. Interacoustics therefore expects that local sorting and waste regulations for disposal of electric and electronic equipment are followed, and that the device is not discarded together with unsorted waste.

In case the distributor of the product offers a take-back scheme, this should be used to ensure correct disposal of the product.



## 2 Unpacking and installation

### 2.1 Unpacking and Inspection

#### **Check for damage**

When the AD629 is received, ensure that you have received all the components on the shipping checklist. All the components should be checked visually for scratches and missing parts before use. All the contents of the shipment have to be checked for their mechanical and electrical functioning. If the equipment is found faulty, please contact your local distributor immediately. Keep the shipping materials for the carrier's inspection and insurance claim.

#### **Keep carton for future shipment**

The AD629 comes with shipping cartons, which are specifically designed for the components. It is recommended to keep the cartons for future shipments in case of any need for return or service.

#### **Reporting and returning procedure**

Any missing part or malfunction or any damaged components (due to shipment) should be reported immediately to the supplier/local distributor along with the invoice, serial number, and a detailed report of the issue. For any on-site service-related information, please contact your local distributor. If the system / components are to be returned for service, please fill all the details related to product issues in the '**Return Report**,' which is attached to this manual. It is very important that you describe all the known facts about the issue in the return report, as this will help the engineer to understand and solve the problem to your satisfaction. Your local distributor holds the responsibility for coordinating any service/return procedure and related formalities.

#### **Storage**









If you need to store the AD629 for a period, please ensure it is stored under the conditions specified in the section for technical specifications:



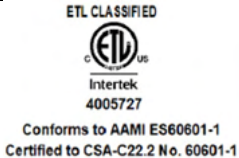

## 2.2 Marking

The following marking can be found on the AD629:

Symbol	Explanation
	Type B applied parts
	Follow instructions for use
	WEEE (EU-directive) This symbol indicates that the product should not be discarded as unsorted waste but must be sent to separate collection for facilities for recovery and recycling.
	The CE-mark in combination with MD symbol indicates that Interacoustics A/S meets the requirements of the Medical Device Regulation (EU) 2017/745 Annex I. Approval of the quality system is made by TÜV – identification no. 0123.
	Year of manufacture
	Manufacturer.
	Medical Device
	ETL listing mark
	Logo



## 2.3 General warnings and precautions

Read these instructions carefully and completely before using the product



Before connecting or while working with this AD629, the user should consider the following warnings and act appropriately.

When connecting the AD629 to the computer, the following warnings must be observed:

- This equipment is intended to be connected to other equipment thus forming a Medical Electrical System. External equipment intended for connection to signal input, signal output or other connectors shall comply with the relevant product standard e.g., IEC 60950-1 for IT equipment and the IEC 60601-series for medical electrical equipment. In addition, all such combinations – Medical Electrical Systems – shall comply with the safety requirements stated the general standard IEC 60601-1, edition 3, clause 16.
- Any equipment not complying with the leakage current requirements in IEC 60601-1 shall be kept outside the patient environment i.e., at least 1.5 m from the patient support or shall be supplied via a separation transformer to reduce the leakage currents.
- Any person who connects external equipment to signal input, signal output or other connectors has formed a Medical Electrical System and is therefore responsible for the system to comply with the requirements. If in doubt, contact qualified medical technician or your local representative. If the AD629 is connected to a PC (IT equipment forming a system) ensure not to touch the patient while operating the PC.

A Separation Device (isolation device) is needed to isolate the equipment located outside the patient environment from the equipment located inside the patient environment. In particular such a Separation Device is required when a network connection is made. The requirement for the Separation Device is defined in IEC 60601-1 clause 16

To avoid the risk of electric shock, this equipment must only be connected to supply mains with protective earth. Do not use any additional multiple socket-outlet or extension cord.

This AD629 contains a coin-type lithium battery. The cell can only be changed by service personnel. Batteries may explode or cause burns, if disassembled, crushed, or exposed to fire or high temperatures. Do not short-circuit.

No modification of this equipment is allowed without Interacoustics' authorization.

Interacoustics will make available on request circuit diagrams, component part lists, descriptions, calibration instructions, or other information that will assist service personnel to repair those parts of this audiometer that are designated by the Interacoustics as repairable by service personnel



Following general cautions to be considered while working with this AD629

Never insert or in any way use the insert headset without a new clean non defect test tip. Always make sure that foam or ear-tip is mounted correctly. Ear tips and foam are meant for single use to avoid cross contamination.

The AD629 is not intended to be used in environments exposed to fluid spills.



It is recommended that the disposable foam ear tips supplied with the optional EarTone5A insert transducers are replaced after each patient tested. Disposable plugs also ensure that sanitary conditions exist for each of your patients, and that periodic cleaning of a headband or cushion is no longer required.

- The black tubing protruding the foam ear tip is attached to the sound tube nipple of the insert transducer.
- Roll the foam tip into the smallest possible diameter.
- Insert into the ear canal of the patient.
- Hold the foam tip until expanded and a seal is achieved.
- After testing the patient, the foam tip including the black tubing is detached from the sound tube nipple.
- The insert transducer should be examined prior to attaching a new foam tip.

The AD629 is not intended to be used in oxygen rich environments or use in conjunction with flammable agents



CAUTION

Although the AD629 fulfills the relevant EMC requirements, precautions should be taken to avoid unnecessary exposure to electromagnetic fields, e.g., from mobile phones, etc. If the device is used adjacent to other equipment it must be observed that no mutual disturbance appears. Please also refer to the appendix regarding EMC.

Use of accessories, transducers, and cables other than specified, with the exception of transducers and cables sold by Interacoustics or representatives, may result in increased emission or decreased immunity of the equipment. For a list of accessories, transducers and cables that fulfil the requirements please also refer to the appendix regarding EMC.

NOTICE: As a part of data protection, ensure to be compliant to all the following points:

1. Use Microsoft supported operating systems
2. Ensure operating systems are security patched
3. Enable database encryption
4. Use individual user accounts and passwords
5. Secure physical and network access to computers with local data storage
6. Use updated antivirus and firewall and anti-malware software
7. Implement appropriate backup policy
8. Implement appropriate log retention policy
9. Ensure to change any default administration passwords

Using operating systems where Microsoft have discontinued software and security support will increase the risk for viruses and malware, which may result in breakdowns, data loss and data theft and misuse. Interacoustics A/S cannot be held liable for your data. Some Interacoustics A/S products support or may work with operating systems unsupported by Microsoft. Interacoustics A/S recommends you to always use Microsoft supported operating systems that are kept fully security updated.

Use only transducers calibrated with actual AD629. To identify a valid calibration, the serial number for the AD629 will be marked on the transducer.



### 3 Getting started - setup and installation

The following shows an overview of the AD629:

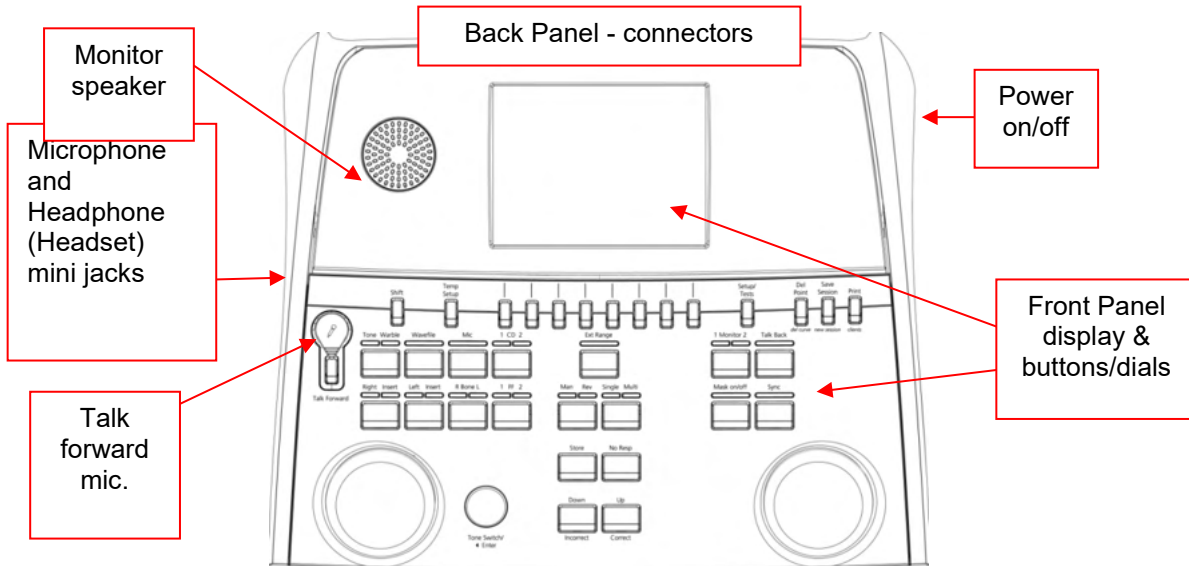

The top left part of the AD629 (display holder) contains monitor speaker. The left side of the AD629 contains two mini jack connectors for a microphone and a headphone – or a headset. This is used for talkback headphone/speaker (TB) and talk forward microphone (TF). A goose neck microphone can be plugged into the top part of the AD629 just above the Talk Forward button. This can be used for talk forward. When not plugged in the goose neck microphone can be placed underneath the display. Please refer to the section about patient communication for more details. The upper right side of the AD629 holds the on/off switch of the AD629.

Make sure that the audiometer is placed so that the patient cannot see/hear of the clinician uses the AD629



### 3.1 Back panel external connections – standard accessories

The back panel contains all the rest of the main connectors (sockets):

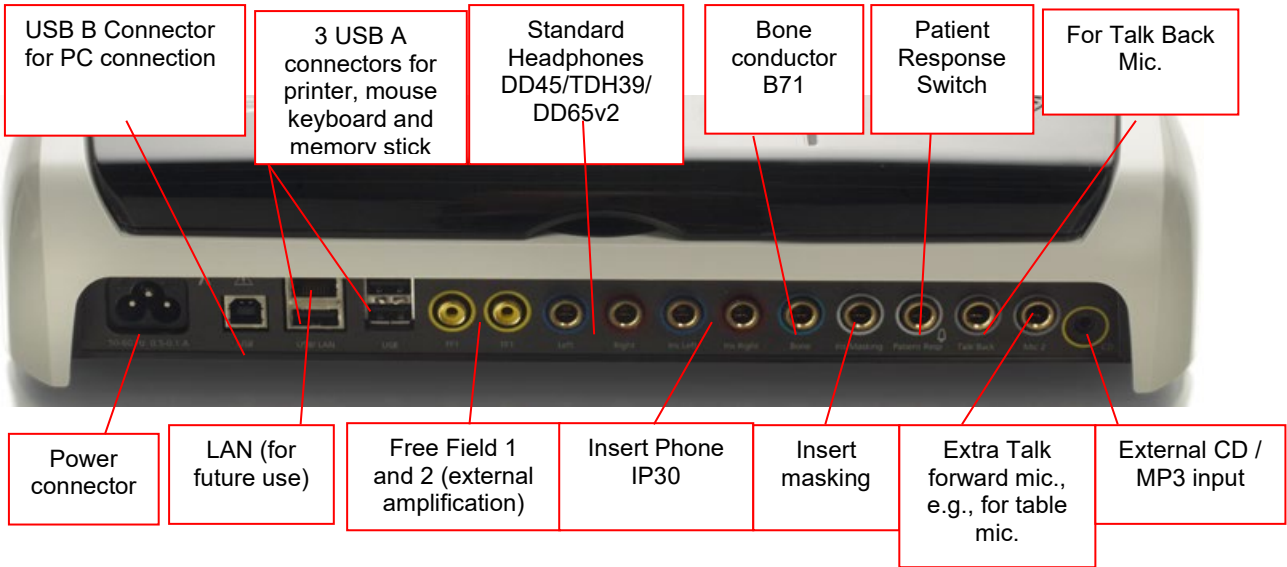

#### Special notes:

- In addition to the standard DD45 headset, three other air conduction transducers may be used (they all connect to specific outputs on the AD629):
  - DD450: High Frequency requires a HF headset
  - DD65v2: Circumaural headset can be used instead of DD45
  - IP30 insert phone is the standard insert phone
- The LAN connection is currently not used for any application (only internally in production)
- Mic 2: Please refer to the section about Patient Communication (Talk Forward and Talk Back)
- CD-input: It is required that any attached CD-player has a linear frequency response in order to comply with the requirements of IEC 60645-2
- USB connections is used for:
  - PC connection to Diagnostic Suite (the large USB connector)
  - Direct print
  - PC-keyboard (for entering client names)

### 3.2 PC-Interface

Please refer to the Diagnostic Suite operation manual regarding hybrid mode (on-line and PC-operated mode) as well as patient/session data transfer.



### 3.3 Patient communication and monitoring

#### 3.3.1 Talk Forward

Talk Forward is activated by the “Talk Forward” button (21). AD629 contains three microphone connectors which will work in the following priority (depending on which one(s) is connected):

- Priority 1: The mini jack in the left side of the AD629 – can be used with a headset together with the headphone connector. This has the first priority.
- Priority 2: The swan neck microphone (1) of the AD629 is located above the “Talk Forward” (21) button. If no mic. is connected to the priority 1 mic., this will be used.

The image below will be shown while the talk forward (21) is active (by hold the button down) where the calibration (gain) level and intensity level for patient communication can be adjusted. To change the calibration level the clinician would adjust the HL dB dial (41) to the appropriate level. To adjust the Intensity level the dial in channel 2 (43) would be used.

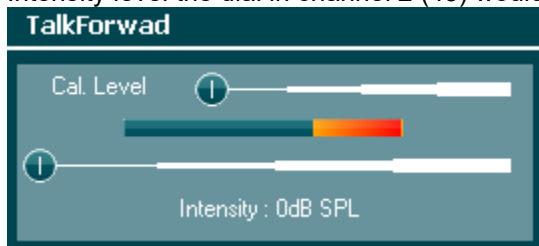

#### 3.3.2 Talk Back

The operator may use Talk Back (28) in one of the following ways:

- If no headphone is connected to the Talk Back (left side connector), the voice is wired through the Talk Back speakers next to the display (2).
- If a headphone/headset is connected to the AD629, talk back will come through this instead.

To adjust the TB level, hold down the TB button and use left/right rotary wheels to adjust the level.

#### 3.3.3 Monitoring

Monitoring of channel 1, 2 or both channels together is available by selecting the “Monitor” button (27) once, twice or three times. Selecting it a fourth time will switch off the monitoring function again. To adjust the monitor levels, hold down the monitor button and use left/right rotary wheels to adjust the level.



#### Selecting desired way of listening:

The monitor signal will be available through the monitor headset if connected, the internal monitor speaker.



### 3.4 Operating instructions

The figure below shows the outline of the front plate of the AD629 including buttons, dials, and display:

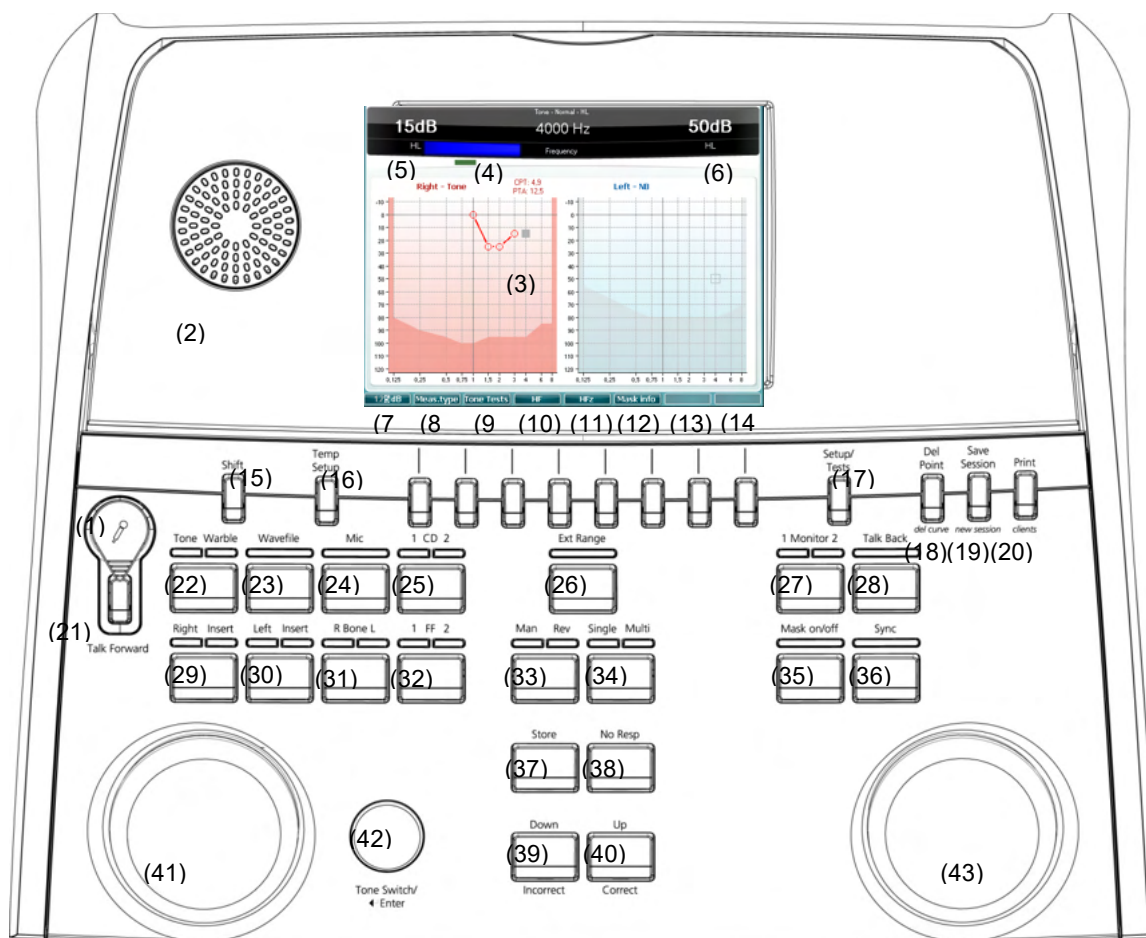

The following table describes the functions of the various buttons and dials.



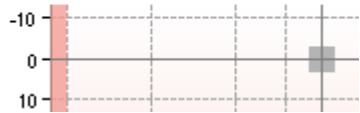

	Name(s)/Function(s)	Description
1	Microphone	For live voice speech and talk forward instruction to the patient in the test cabin.
2	Talk back Speaker	For speech feedback from the patient in the test cabin.
3	Color Display Screen	For displaying the different test screens. Will be further explained in the sections describing the individual tests.
4	Tone and Response Indicator	Indication light seen when a tone is presented to the patient. Indication light seen when the patient activates the patient signal using the patient response.
5	Channel 1	Indicates intensity level for channel 1, e.g.: <div style="text-align: center; border: 1px solid black; padding: 5px; width: fit-content; margin: 10px auto;"> <b>15dB</b> HL         </div>



	Name(s)/Function(s)	Description
6	Masking / Channel 2	Indicates masking or Intensity level for channel 2, e.g.: 
7-14	Function Keys	These keys are context sensitive and depend on the selected test screen. Will be further explained in the sections describing the individual tests
15	Shift	The shift function will enable the clinician to activate the sub functions written in <i>italic</i> underneath the buttons.
16	Temp Setup	Allows the clinician to make temporary changes in certain settings within each test. To save the changes as default (for the next session) press “Shift (15)” and then <b>SaveAsDef</b> (14). Choose between the different settings using the right rotary wheel (43). Change the individual settings using the left rotary wheel (41).
17	Setup / Tests	The common setting menu can be accessed for more specific tests and changes to general settings can be made. This is also where the special tests are accessed: Auto tests (HW, Békésy), MHA, SISI. To save the changes as default (for the next session) press “Shift (15)” and then <b>SaveAsDef</b> (14). Choose between the different settings using the right rotary wheel (43). Change the individual settings using the left rotary wheel (41).
18	Delete / <i>del curve</i>	Delete points during testing delete. Delete the entire test curve of a graph by holding “Shift (15)” together with this button.
19	Save Session/ <i>New Session</i>	Saving a session after testing or alternatively add a new session by holding the “Shift (15)” together with this button. (A new session will recall the default settings saved in 16 and 17)
20	Print	Allows results to be printed directly after testing (via a supported USB printer).
21	Talk Forward	Instruction to the patient directly through his headphones via the microphone can be given. The intensity changes by turning the “HL dB” (41) while holding the “Talk Forward” button.
22	Tone / Warble	Pure tones or warble tones can be chosen as stimuli by activating this button once or twice. The stimuli chosen will be shown on the display, e.g.: <b>Right - Warble tone</b> 
23	Wavefile	Enables one to perform speech testing using loaded wave files, i.e., pre-recorded speech material. Please see setup under Temp Setup (15). Requires installation of speech material.





	Name(s)/Function(s)	Description
24	Mic	For live speech testing through the microphone (1). The VU meter can be seen on the display screen. Adjust the microphone gain by holding down the Mic button for one second. 
25	1 CD 2	By pressing this function once or twice it is possible to have recorded speech in either channel 1 or channel 2 separately. Adjust the gain of CD 1 and 2 by holding down the CD button for one second. 
26	Ext Range	Extended Range: Usually the maximum output is e.g., 100dB but if a higher output e.g., 120 dB is needed then “Ext Range” can be activated when reaching a certain level.
27	Ch 1 Monitor 2	With the activation of this button, presentation to the patient from e.g., CD can be heard through the built in monitor of the AD629 or monitor headset in both channel 1 and 2. Adjust the gain by holding down the button for one second. 
28	Talk Back	Talk back, when active allows the clinician to hear comments or responses from the patient through the AD629 or monitor headset. Adjust the gain by holding down the button for one second. 
29	Right / Insert	For selecting the right ear during testing. Insert phones for the right ear can be activated by pressing twice.
30	Left / Insert	For selecting the left ear during testing. Insert phones for the left ear can be activated by pressing twice.
31	R Bone L	For bone conduction testing. <ul style="list-style-type: none"><li>• First push: selects the right ear for testing.</li><li>• Second push: selects the left ear for testing.</li></ul>
32	1 FF 2	Pressing “1 FF 2” will select free field speaker as output for Channel 1. <ul style="list-style-type: none"><li>• First push: Free Field speaker 1</li><li>• Second push: Free Field speaker 2</li></ul>
33	Man / Rev	Manual / Reverse tone presentation modes: <ul style="list-style-type: none"><li>• First push: Manual tone presentation each time “Tone Switch” (42) is activated.</li></ul>



Name(s)/Function(s)	Description
34 Single / Multi	<ul style="list-style-type: none"><li>• Second push: The reverse function- continuous tone presentation which will be interrupted each time “Tone Switch” (42) is activated.</li></ul> <p>Pulsing modes:</p> <ul style="list-style-type: none"><li>• First push: the tone presented will have a pre-set length when “Tone Switch” is activated. (Set up in the “Setup/Tests” (17)).</li><li>• Second push: the tone will be pulsing continuously.</li><li>• Third push: returns back to normal mode.</li></ul>
35 Mask On/Off	<p>Masking channel on/off:</p> <ul style="list-style-type: none"><li>• First push: turns masking on</li><li>• Second push: turns masking off</li></ul>
36 Sync	<p>This allows the masking attenuator to the tone attenuator to be activated. This option is used for e.g., synchronous masking.</p>
37 Store	<p>Use this function to store test thresholds / results.</p>
38 No Resp	<p>Use this function if the patient has shown no response to stimuli.</p>
39 Down / Incorrect	<p>Used to decrease the frequency level.</p> <p>The AD629 has an incorporated automatic speech score counter. Therefore, as a second function you can use this button as an “Incorrect” button when performing speech tests. For automatic speech score counting while testing speech push this button after each word not heard correctly by the patient.</p>
40 Up / Correct	<p>Used to increase the frequency level.</p> <p>The AD629 has an incorporated automatic speech score counter. Therefore, as a second function you can use this button as a “Correct” button when performing speech tests. For automatic speech score counting while testing speech push this button after each word heard correctly by the patient.</p>
41 HL db Channel 1	<p>This allows for the adjusting of the intensity in channel 1 shown at (5) in the display.</p>
42 Tone Switch / Enter	<p>Used for tone presentation where the “Tone” light (4) will show. Can also be used as “Enter” (selection) button.</p>
43 Masking Channel 2	<p>Adjust the intensity level in channel 2 or masking levels when masking is used. Shown at (6) in the display.</p>



### **3.5 Tests screens and function key descriptions**

The following tests are available from the Test (17) button. Use rotary wheels (41)/(43) to select the individual test screen:

- Tone
- Stenger
- ABLB – Fowler
- Tone in noise – Langenbeck
- Weber
- Speech
- Auto – Hughson Westlake
- Auto – Békésy
- QuickSIN – Quick speech in noise
- SISI – Short increment sensitivity index
- MHA – Master Hearing Aid
- HLS – Hearing Loss Simulator

The (optional) HF (High Frequency) / HFz (High Frequency Zoom) test features are activated from the Tone Screen – i.e. as extensions to the Tone audiogram test screen.

Please note that the tests available in this list depend on the test licenses installed on the AD629. This may also vary from country to country.



### 3.5.1 Tone test

The Tone test screen is used for pure/warble tone audiometry via normal headphones or insert phones, bone conduction, free field audiometry, multi frequency (optional test) as well as high frequency/high frequency zoom (optional). When using Bone conduction, masking must be applied to obtain correct results.

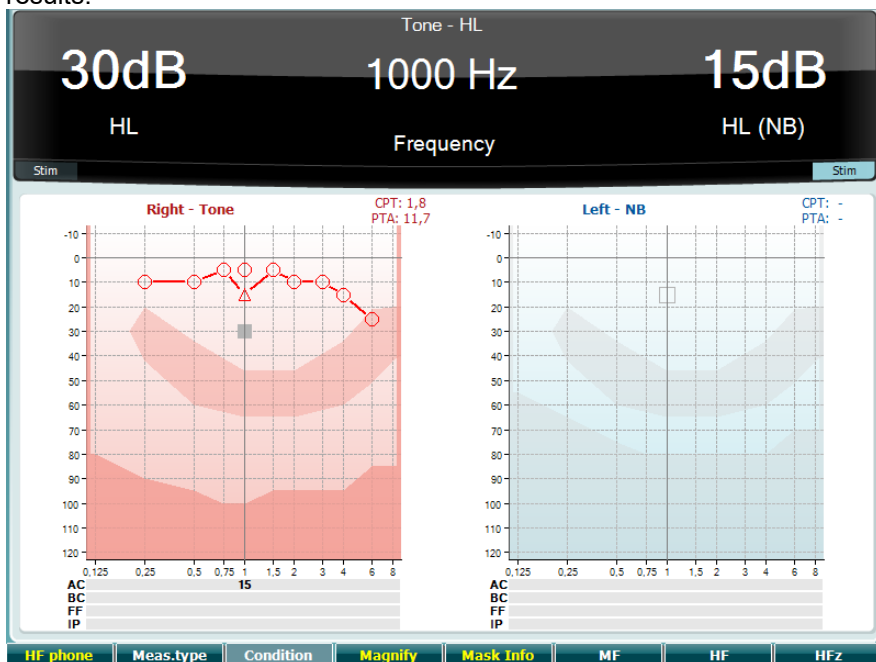

Function Key	Description
10 <b>HF phone</b>	Only available if High Frequency is available (optional license) on the AD629. Selects the HF phone connected to the separate HF connectors.
11 <b>Meas.type</b>	Choose between HL, MCL and UCL by holding the Function Key (8) and select the required measuring type by using one of the rotary wheels (41)/(43)
12 <b>Condition</b>	Not used in this test screen.
13 <b>Magnify</b>	Switch between magnified top bar and normal sized top bar.
14 <b>Mask Info</b>	View the masking levels (dual audiogram mode only).
15 <b>MF</b>	Multi frequency (optional MF license)
16 <b>HF</b>	High Frequency (optional HF license)
17 <b>HFz</b>	High Frequency Zoom (optional HF license)

### 3.5.2 Stenger Test

The Stenger test is a test when a patient is suspected of feigning/faking a hearing loss and is based on the auditory phenomenon, "The Stenger Principle", that states that only the louder of two similar tones presented to both ears at the same time will be perceived. As a general rule it has been recommended to perform the Stenger test in case of unilateral hearing losses or significant asymmetries.

Please refer to the Tone Test section above for key function descriptions for Function Keys (7), (10), (11), (12), (13), (14).



### 3.5.3 ABLB - Fowler test

ABLB (Alternate Binaural Loudness Balancing) is a test to detect perceived loudness differences between the ears. The test is designed for people with unilateral hearing loss. It serves as a possible test for recruitment.

The test is performed at frequencies where recruitment is presumed. The same tone is presented alternatively to both ears. The intensity is fixed in the impaired ear (20 dB above pure tone threshold). The task of the patient is to adjust the level of the better ear until the signal in the two ears is of equal intensity. Note however that the test may also be performed by fixing the intensity in the normal hearing ear and having the patient set the tone for the impaired ear.

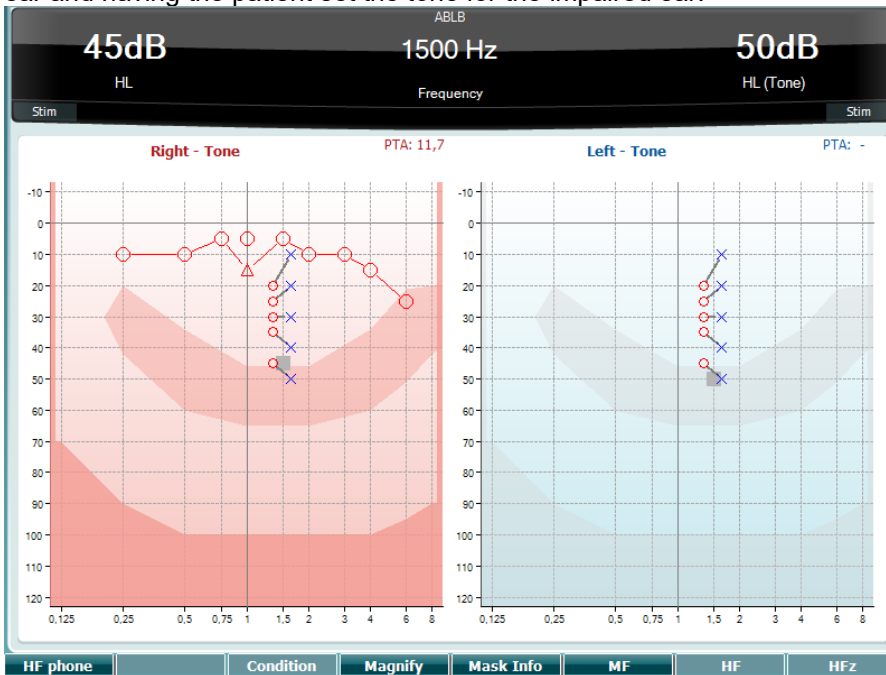

Please refer to the Tone Test section above for key function descriptions for Function Keys (7), (10), (11), (12), (13), (14).

### 3.5.4 Tone in noise test (Langenbeck Test)

Please refer to the Tone Test section above for key function descriptions for Function Keys (7), (8), (10), (11), (12), (13), (14).



### 3.5.5 Weber

The Weber test distinguished between conductive and sensorineural hearing loss through use of a bone conductor. Use the indications to show where the tone is perceived. If the patient hears the tone better in the poorer ear the hearing loss is conductive, and the tone is heard better in the better ear the hearing loss is sensorineural at the given frequency.

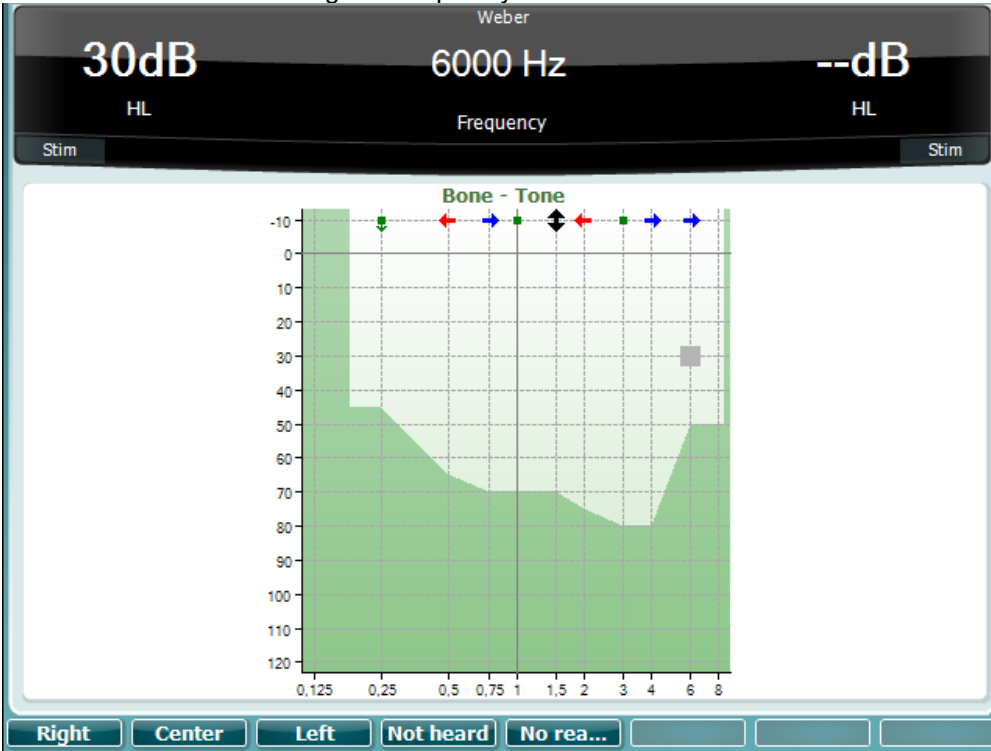

The symbols for Weber correspond with the soft buttons:

Percieved right	Percieved center	Percieved left	Not heard	No reaction

### 3.5.6 Speech test

Speech testing can be done via pre-recorded wave files (23) (if installed), microphone (43) or CD input (25).

Most people acquire hearing aids because they themselves or their relatives report that they have trouble hearing speech. Speech audiometry has the advantage of other ears speech signals and is used to quantify the patient's ability to understand everyday communication. It examines the patient's processing ability in relation to their degree and type of hearing loss which can vary greatly between patients with the same hearing loss configuration.

Speech audiometry can be performed using a number of tests. For example, SRT (Speech Reception Threshold) refers to the level at which the patient can repeat 50% of the presented words correctly. It serves as a check of the pure tone audiogram, gives an index of hearing sensitivity for speech, and helps determine the starting point for other supra-threshold measures such as WR (Word Recognition). WR is sometimes also referred to as SDS (Speech Discrimination Scores) and represents the number of words correctly repeated expressed as a percentage.



Note that there is a predictable relationship between the patients pure tone threshold and speech threshold. Speech audiometry may therefore be useful as a cross-check of the pure tone audiogram.

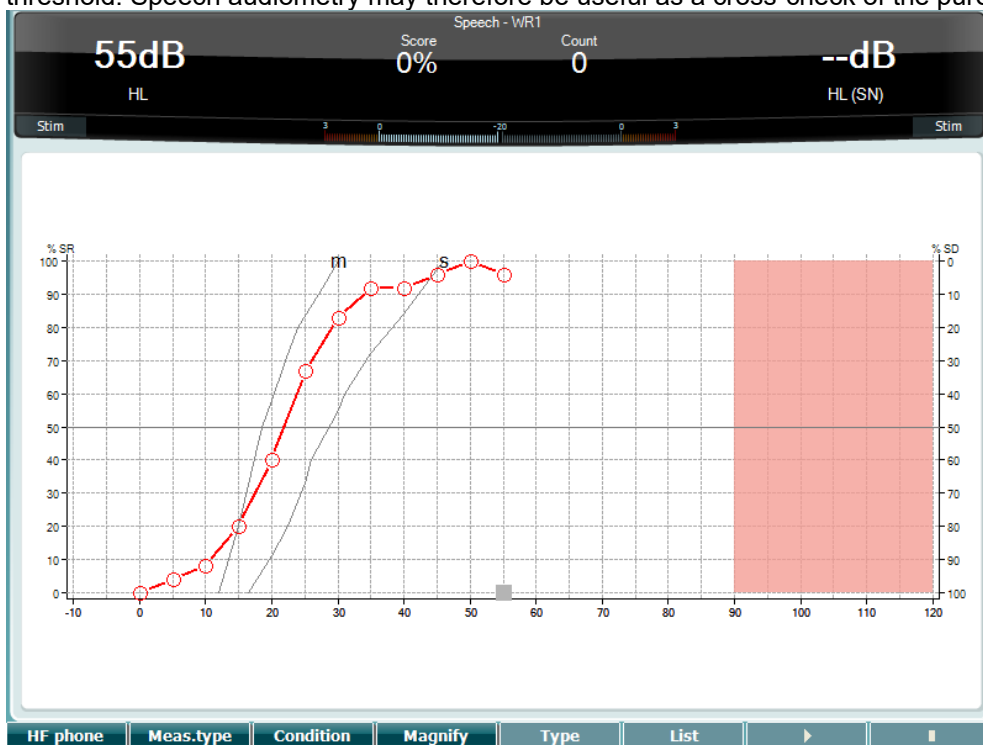

The speech screen set up in graph mode using live voice/MIC (24) - under Setup (16).

Hold in the Mic (24) and CD (25) button in to adjust the live voice or CD input level. Adjust the levels for the until you reach an average of approximately 0 dB VU on the VU meter.

### NOTICE

If the speech and calibration signal are not the same level, it must be manually corrected.



The speech screen set up in table mode using wave files (23) - under Setup (16).

	Function Key	Description
10	<b>HF phone</b>	Only available if High Frequency is available (optional license) on the AD629. Selects the HF phone connected to the separate HF connectors.
11	<b>Meas.type</b>	Choose between HL, MCL and UCL by holding the Function Key (8) and select the required measuring type by using one of the rotary wheels (41)/(43).
12	<b>Condition</b>	The condition under which the speech test is done: None, Aided, Binaural or Aided & Binaural.



**Function Key**

**Description**

13 **Magnify**

Switch between magnified top bar and normal sized top bar.

14 **Type**

Use the HL dB dial (41) to select the different items from the lists:

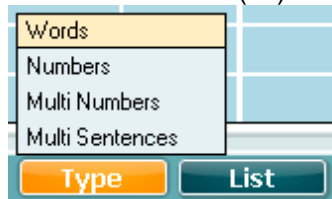

15 **List**

Different lists can be changed in the "List" option. Use the HL dB dial (41) to select the different items from the lists.

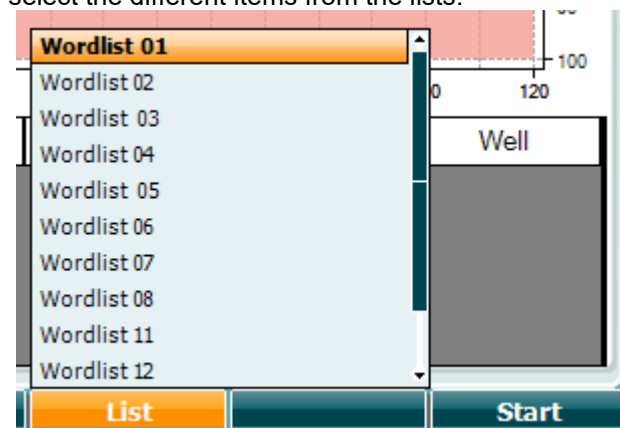

16 **Start**

Start playing the wave files.

17 **End**

Stop playing the wave files.

When the Wavefile test is started, the F-buttons will change to recording mode.

In recording mode, if the protocol has been set to continue/timeout after the word has been played, the word will be grey colored, waiting for the operator's input.

The input can either be Correct(40) / Incorrect(39) on the keyboard or by using the Phoneme score on the F-buttons. The tested can be paused on the play/pause button.

If the recording mode has been set to manual, the words can be selected, one by one, by using the forward/reverse button on the F-buttons, press play to play the word.

When the word-list is completed or another track has to be selected, use the End F-button to leave the recording mode.

Play / Pause	Forward / Reverse	Stop Track	Phoneme score 0-4				





### 3.5.6.1 Speech – CH2On

This test screen is the same as for speech. When in Speech – Ch2On, the speech material is presented binaurally.

### 3.5.6.2 Speech in noise

This test screen is the same as for speech. When in Speech in noise, the speech material and speech in noise is presented in the same ear.

### Hughson-Westlake Test

Hughson Westlake is an automatic pure tone test procedure. The threshold of hearing is defined as 2 out of 3 (or 3 out of 5) correct responses at a certain level in a 5dB increase and a 10dB decrease test procedure.

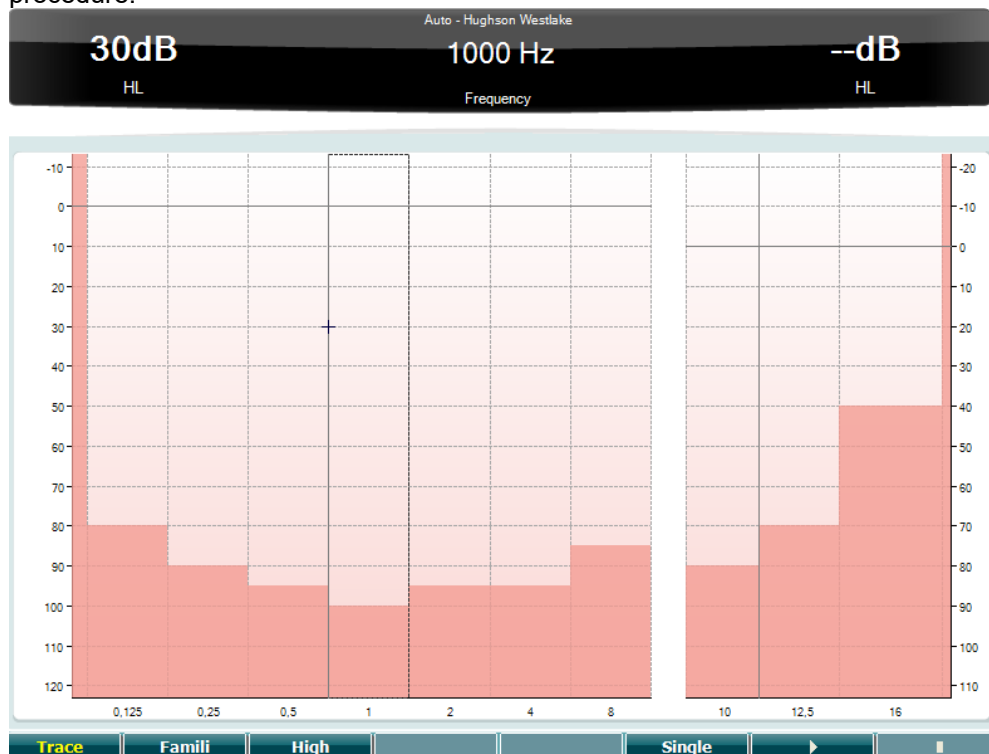

	Function Key	Description
10		Show traces
11		Select other ars21y
12		Test high frequencies
15		Single Freq test
16		Start test. Tests all frequencies.
17		Stop test.



### Békésy test

Békésy is a type of automatic audiometry. It is diagnostically important from the classification of the results into one of the five types (after Jerger, et al) when responses to continuous and pulsed tones are compared. The Békésy test is a fixed frequency test. Pure tone or narrow band noise can be selected. As a standard a continuous tone is selected for the Békésy test, if pulsing tones are preferred this can be changed by pressing “Settings” (16) and changing continuous to pulse.

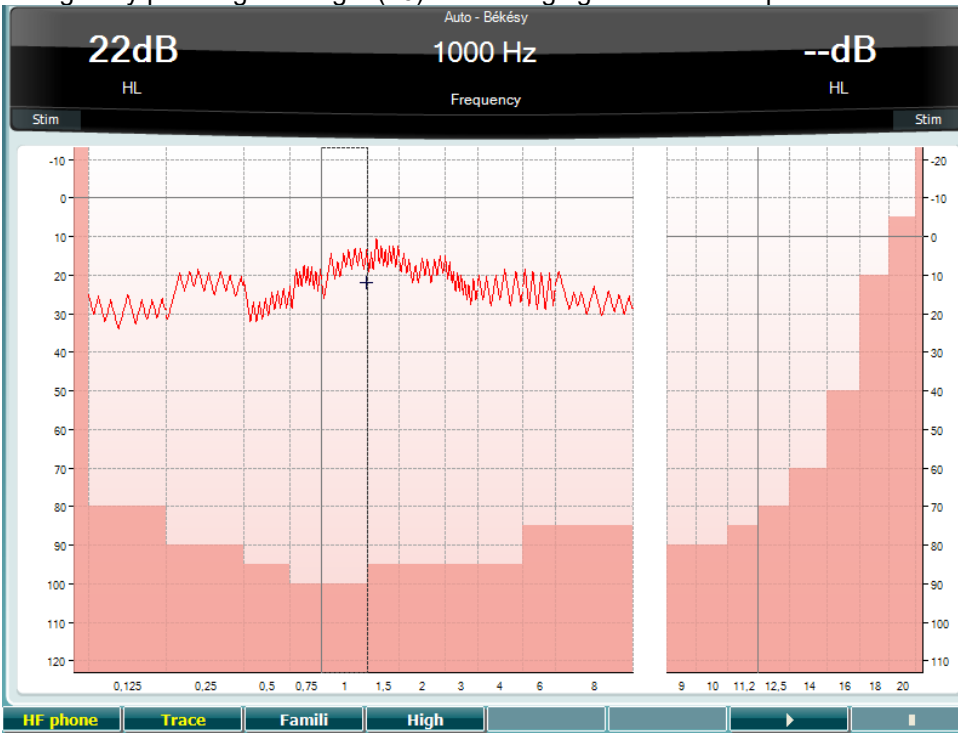

Please refer to the HW Test section above for key function descriptions for Function Keys (8), (9), (10), (13), (14).



## QuickSIN test

Difficulty with hearing in background noise is a common complaint among hearing aid users. Therefore, the measurement of SNR loss (signal-to-noise ratio loss) is important because a person's ability to understand speech in noise cannot be reliably predicted from the pure tone audiogram. The QuickSIN test was developed to provide a quick estimate of SNR loss. A list of six sentences with five key words per sentence is presented in four-talker babble noise. The sentences are presented at pre-recorded signal-to-noise ratios which decrease in 5-dB steps from 25 (very easy) to 0 (extremely difficult). The SNRs used are: 25, 20, 15, 10, 5 and 0, encompassing normal to severely impaired performance in noise. For more information please refer to Etymotic Research's *QuickSIN™ Speech-in-Noise Test* manual, version 1.3.

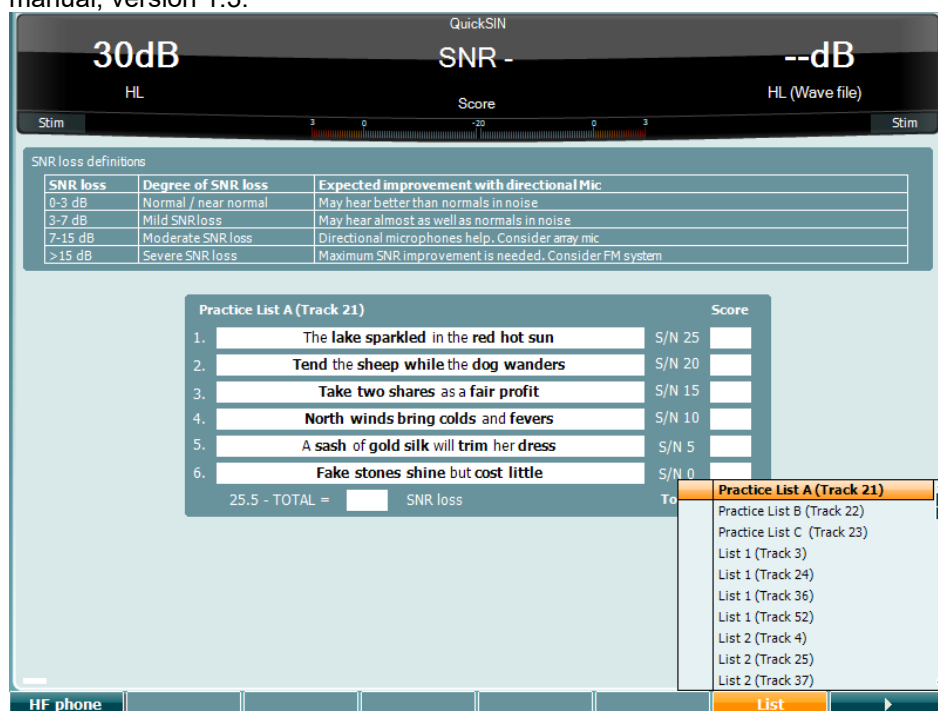

### Function Key

### Description

- |    |  |  |
|----|--|--|
| 10 |  | Only available if High Frequency is available (optional license) on the AD629. Selects the HF phone connected to the separate HF connectors. |
| 16 |  | Different lists can be changed in the "List" option. Use the HL dB dial (41) to select the different items in the lists.                     |
| 17 |  | Start QuickSIN test  |



### SISI test

SISI is designed to test the ability to recognise 1 dB increase in intensity during a series of bursts of pure tones presented 20 dB above the pure tone threshold for the test frequency. It can be used to differentiate between cochlear and retro cochlear disorders as a patient with a cochlear disorder will be able to perceive the increments of 1 dB, as where a patient with a retro cochlear disorder will not.

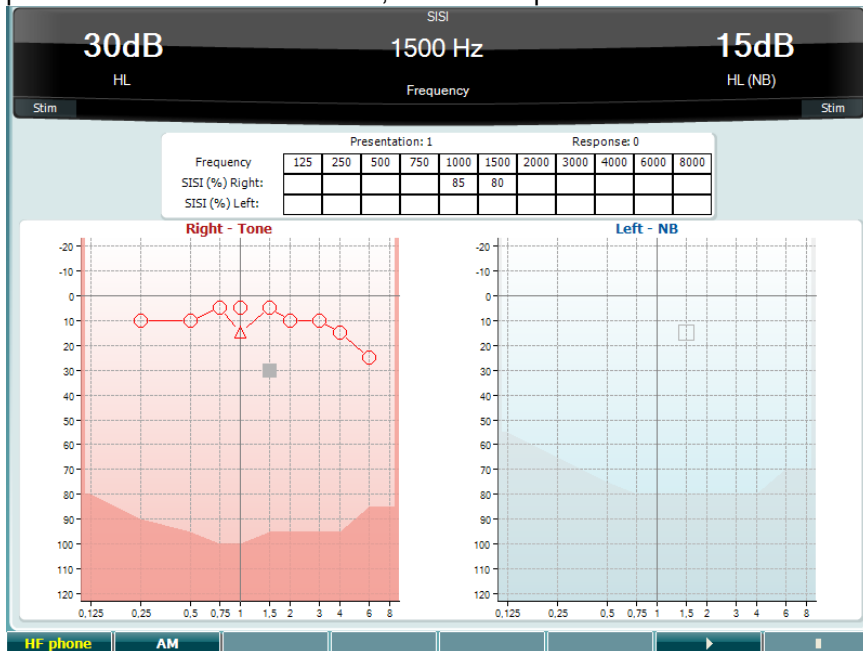

	Function Key	Description
10		Only available if High Frequency is available (optional license) on the AD629. Selects the HF phone connected to the separate HF connectors.
11		Amplitude Modulation
16		Start SISI test.
17		Stop SISI test.



### Master hearing aid test

MHA is a hearing aid simulator that consists of three high pass filters of -6 dB, -12 dB, -18 dB per octave and a HFE filter (High Frequency Emphasis) equivalent to -24 dB per octave through the audiometric headphones. This gives a sense of the benefits of a hearing aid and what could eventually be gained by getting properly fitted hearing aids. The filters can be activated individually on both channels enabling the audiometer to serve as a 2 channel master hearing aid.

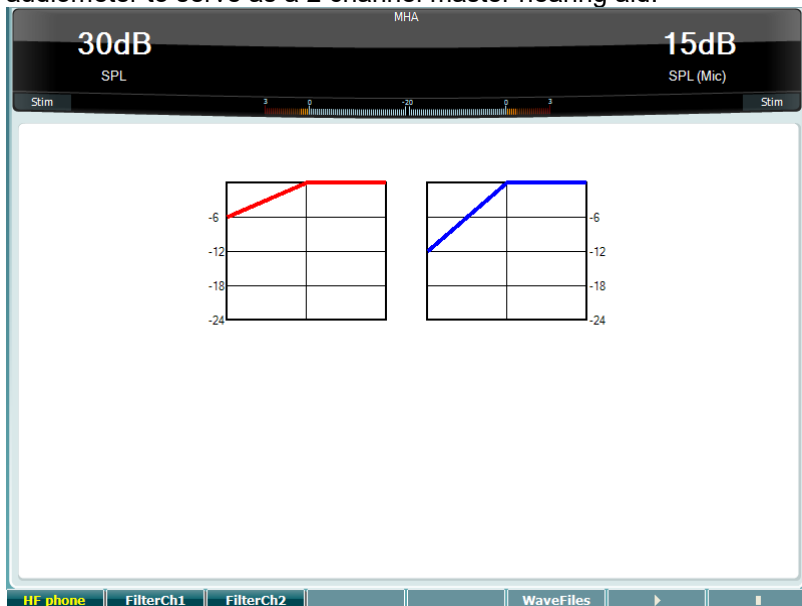

	Function Key	Description
10		Only available if High Frequency is available (optional license) on the AD629. Selects the HF phone connected to the separate HF connectors.
11		Filter channel 1
12		Filter channel 2
15		If MHA/HIS wave file is installed, they can be selected here.
16		Start MHA test
17		Stop MHA test

MHA/HIS wave files can be installed the following way:

1. Zip the selected wave files into a file named "update\_mha.mywavefiles.bin" (make sure the file extension is bin and not zip)
2. Copy the files to a newly FAT32 formatted USB memory stick
3. Insert the stick into one of the USB connections on the AD629.
4. Go to Common Setup and press "Install"
5. Wait for the installation to complete.
6. Restart the AD629.



### Hearing loss simulation test

The HLS offers a simulation of the hearing loss through the audiometric headphones or the high frequency headset and is primarily aimed at the family members of the hearing impaired. It is a valuable tool as a hearing loss in many families may result in frustrations and misunderstandings. Knowing what the hearing loss actually sounds like gives an impression of what the hearing impaired goes through every day.

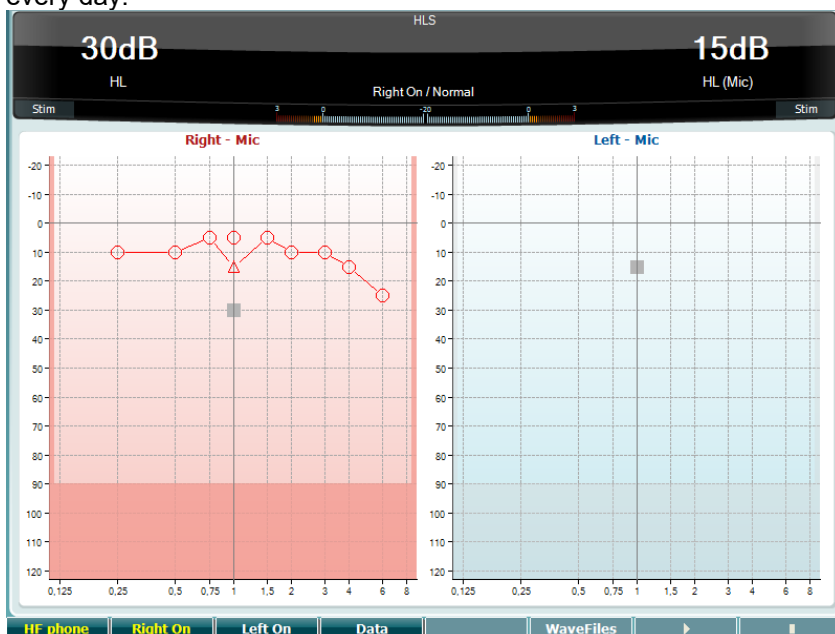

	Function Key	Description
10		Only available if High Frequency is available (optional license) on the AD629. Selects the HF phone connected to the separate HF connectors.
11		Right channel on.
12		Left channel on.
13		Select which audiogram data to use for the HLS test.
15		If MHA/HIS wave file is installed, they can be selected here.
16		Start HLS test
17		Stop HLS test

The HIS test uses the same wave files as the MHA test screen and is installed in the same way. Please see above.



### 3.6 Setup

Allows the clinician to make changes in certain settings within each test and to change the common settings for the AD629. A single push will by default enter the selected Test Settings menu. To enter other settings menus, hold the “Setup” button and use one of the rotary wheels (41)/(43) to select:

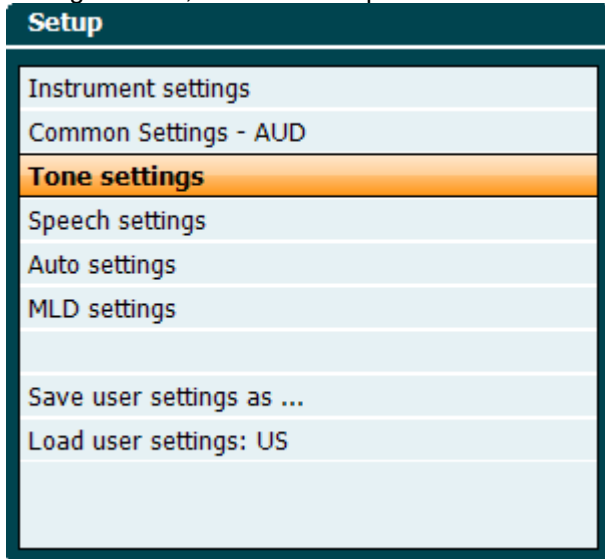

To save the settings use “Save all settings as....”

To use another user setting (protocol/profile) use “Load user settings: ‘name of user setting’.....”

Inside a settings menu, choose between the different settings using the right rotary wheel (43). Change the individual settings using the left rotary wheel (41). Here an example from the Tone settings dialogues where “Aided” is in focus:

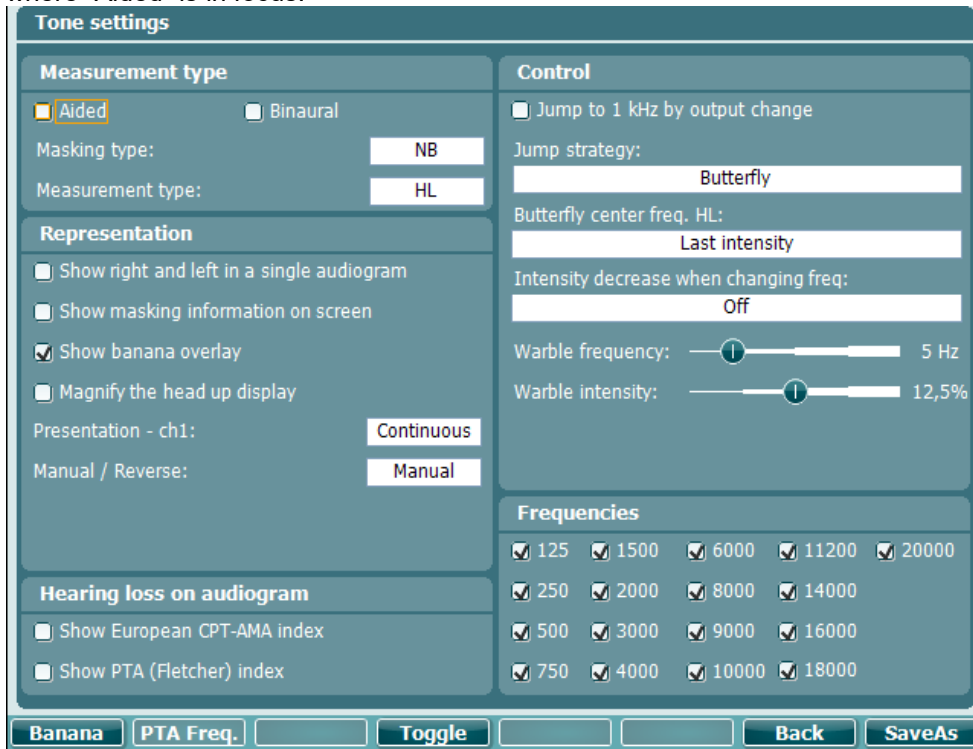

For a detailed description of the setting dialog, please refer to AD629 Quick Guides found here: <http://www.interacoustics.com/ad629>



### 3.6.1 AD629 setup

The screen shot below shows the AD629 settings menu:

Instrument settings	
<b>License: SN: 34567890</b> AUD key: <b>014L3U3RDZF7UXS64H3GVA2</b>	<b>System</b> Date & Time: 07-03-2017 15:17:11
<b>Light</b> Display light: [Slider] LED light: [Slider]	<b>Printer</b> Printer type: MPT-III Printing color mode: Monochrome (B&W)
<b>Session Settings</b> <input type="checkbox"/> Keep Session on Save	
<b>Client</b>	<b>Install</b> <b>Language</b> <b>Change</b> <b>Exit</b>

### 3.6.2 Common settings

The screen shot below shows the common settings menu:

Common settings	
<b>Intensity (Tone, Speech, SISI)</b> Intensity steps: <b>5 dB</b> Default level when changing output: 30 dB Ch2 start intensity (From Off -> ON): 15 dB Ch2 intensity when changing freq.: Off	<b>Automatic output selection</b> <input type="checkbox"/> Use insert masking for bone
<b>Representation</b> <input checked="" type="checkbox"/> Show maximum intensities: <input checked="" type="checkbox"/> Show masking cursor Default Symbols: <b>International</b>	<b>Standard</b> Tone standard: ANSI Speech standard: ANSI Filter mode: Linear
<b>Weber</b> <input checked="" type="checkbox"/> Show on tone audiogram <input checked="" type="checkbox"/> Show on print	<b>Print</b> <input type="checkbox"/> Output thresholds in single graph with HF
<b>Pulse</b> Multi, pulse length: [Slider] 500 ms Single, pulse length: [Slider] 500 ms	<b>Data handling settings</b> <input type="checkbox"/> Save IP measurement as AC
<b>Start-up</b> <input type="checkbox"/> Ask for setting at startup	<b>Patient Response</b> <input type="checkbox"/> Enable Patient Response Sound Response volume: [Slider] 0
<b>Client</b>	<b>Change</b> <b>Back</b> <b>SaveAs</b>





In Common Setup, “Shift+Setup” opens the following About box:

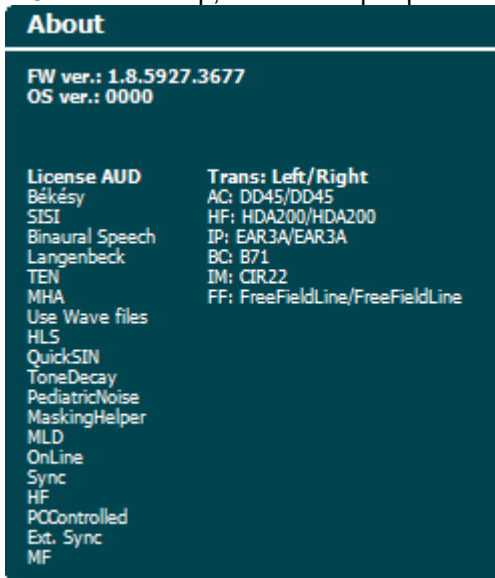

	<b>Function keys</b>	<b>Description</b>
10		Select client list.
11		Install new firmware or wave files from USB stick.
	/	
		Uninstall items. Use shift to activate this.
16		Go back.
17		Save user setting (protocol)

New audiometric symbol schemes are installed via the Diagnostic Suite under General Setup. The same applies to the clinic logo shown on the direct printout.



### 3.6.3 Tone setting

The screen shot below shows settings for pure tone testing:

**Tone settings**

<p><b>Measurement type</b></p> <p><input checked="" type="checkbox"/> Aided    <input type="checkbox"/> Binaural</p> <p>Masking type: <input type="text" value="NB"/></p> <p>Measurement type: <input type="text" value="HL"/></p> <p><b>Representation</b></p> <p><input type="checkbox"/> Show right and left in a single audiogram</p> <p><input type="checkbox"/> Show masking information on screen</p> <p><input checked="" type="checkbox"/> Show banana overlay</p> <p><input type="checkbox"/> Magnify the head up display</p> <p>Presentation - ch1: <input type="text" value="Continuous"/></p> <p>Manual / Reverse: <input type="text" value="Manual"/></p> <p><b>Hearing loss on audiogram</b></p> <p><input type="checkbox"/> Show European CPT-AMA index</p> <p><input type="checkbox"/> Show PTA (Fletcher) index</p>	<p><b>Control</b></p> <p><input type="checkbox"/> Jump to 1 kHz by output change</p> <p>Jump strategy: <input type="text" value="Butterfly"/></p> <p>Butterfly center freq. HL: <input type="text" value="Last intensity"/></p> <p>Intensity decrease when changing freq: <input type="text" value="Off"/></p> <p>Warble frequency: <input type="range" value="5"/> 5 Hz</p> <p>Warble intensity: <input type="range" value="12.5"/> 12,5%</p> <p><b>Frequencies</b></p> <p><input checked="" type="checkbox"/> 125   <input checked="" type="checkbox"/> 1500   <input checked="" type="checkbox"/> 6000   <input checked="" type="checkbox"/> 11200   <input checked="" type="checkbox"/> 20000</p> <p><input checked="" type="checkbox"/> 250   <input checked="" type="checkbox"/> 2000   <input checked="" type="checkbox"/> 8000   <input checked="" type="checkbox"/> 14000</p> <p><input checked="" type="checkbox"/> 500   <input checked="" type="checkbox"/> 3000   <input checked="" type="checkbox"/> 9000   <input checked="" type="checkbox"/> 16000</p> <p><input checked="" type="checkbox"/> 750   <input checked="" type="checkbox"/> 4000   <input checked="" type="checkbox"/> 10000   <input checked="" type="checkbox"/> 18000</p>
---	---

Function key	Description
10 <input type="button" value="Banana"/>	Show settings for the speech banana.
16 <input type="button" value="Back"/>	Go back.
17 <input type="button" value="SaveAs"/>	Save user setting (protocol)



### 3.6.4 Speech settings

The screen shot below shows settings for Speech testing:

**Speech settings**

**Measurement Type**  
 Aided  Binaural

**Representation**  
Masking type:  
SN  
 Table mode  Graph mode  
Measurement type:  
WR1  
 Magnify the head up display  
 Select SRT for numbers speech material

**Link stimulus type to curves**

WR1	--
WR2	--
WR3	--
SRT	--

**Controls**  
Number of words (CD & mic only):  
25  
 Reset speech score on intensity change  
 Reset Score on HL to UCL change

**Wave file**  
Table selection:  
Wave running mode:  
Continue  
 correct  incorrect  
if no scoring is entered within  
2 s  
After Scoring wait another  
3 s  
before playing next word.

**Ph Norms** **FF Norms** **Toggle** **Back** **SaveAs**

	Function key	Description
10	<b>Ph Norms</b>	Phoneme norm curve settings.
11	<b>FF Norms</b>	FF norm curve setting.
16	<b>Back</b>	Go back.
17	<b>SaveAs</b>	Save user setting (protocol)



### 3.6.5 Auto settings

	Function key	Description
16		Go back.
17		Save user setting (protocol)

### 3.6.6 Sessions and clients





Save a session (19) after testing or alternatively create a new session by holding “Shift” (15) and pressing the “Save Session” button.

In the “Save Session” (19) menu it is possible to save sessions, delete and create clients and edit client names.

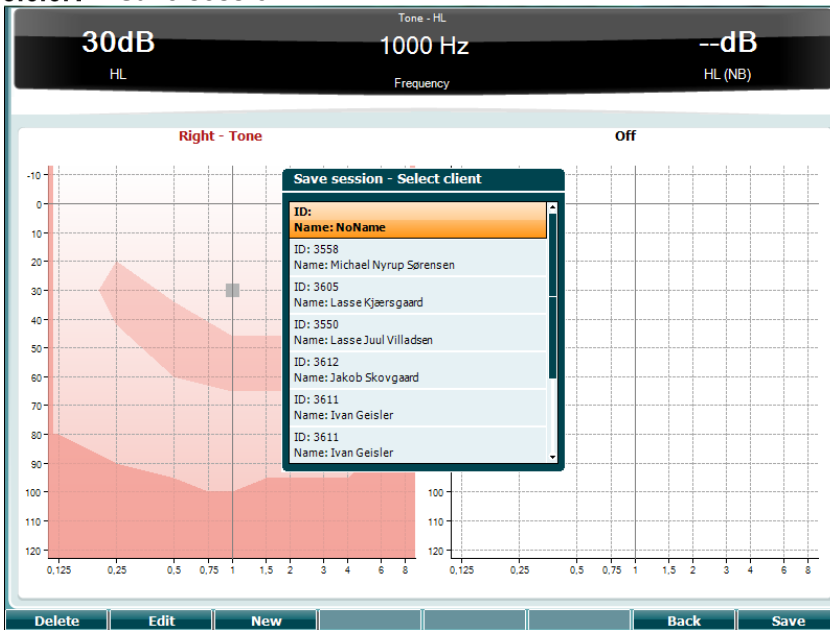



### 3.6.6.1 Save session



Function keys	Description
10 	Delete the selected client.
11 	Edit the selected client.
12 	Create new client.
16 	Return to the session.
17 	Save session under the selected client.

### 3.6.6.2 Clients

Function keys	Description
10 	Delete the selected client.
16 	Return to the session.
17 	Access the sessions saves under the selected client.



### 3.7 Printing

The data from the AD629 can be printed in two ways:

- **Direct printout:** Allows results to be printed directly after testing (via a supported USB printer). The printout logo can be configured via the audiometer itself (see below) or via the Diagnostic Suite (in the General Setup a logo image can be downloaded to the AD629 from the PC).
- **PC:** Measurements can be transferred to the Diagnostic Suite PC program (see separate operational manual) and printed via this. This allows printouts to be fully customized via the Print Wizard. It also allows for combined printouts – e.g. together with the AT235 or Titan Middle Ear Analysers.

### 3.8 AD629 stand alone unit, print logo update

1. Open up the “Paint” program
2. Open up “Image Properties,” by pushing the Ctrl + E keys

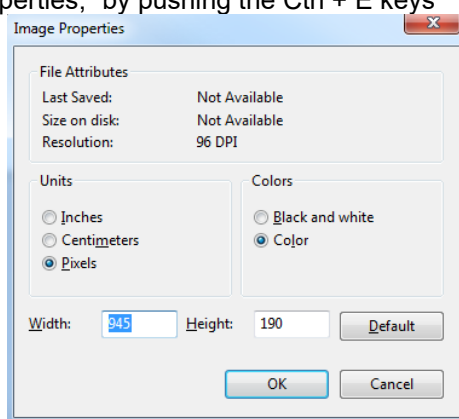

3. Set the “Width” to 945 and the “Height” to 190 as shown. Click on “OK”
4. Edit the Image and the Company data to fit inside the set area
5. Save the created file as “PrintLogo.bmp”
6. Zip the “PrintLogo.bmp” file to the following name “update\_user.logo.bin”  
The “update\_user.logo.bin” file is now ready to be used
7. Find a USB thumb drive with at least 32MB in total size and insert it into your PC
8. Go to My Computer and right click on the USB thumb drive and select ‘Format’ \*\*Note-this will erase everything on your USB thumb drive\*
9. Ensure that ‘FAT32 is selected as your File System- Leave other settings as listed

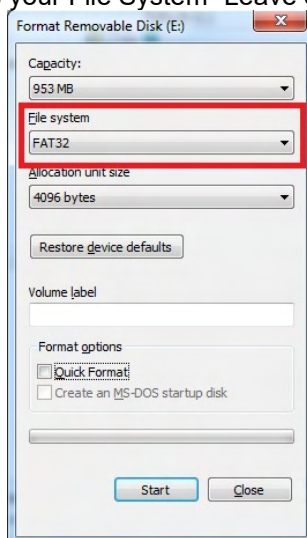



10. Click Start-depending on the size of your thumb drive these may take a while. When the format is complete you will receive a pop-up indicating it has formatted successfully
11. Copy "update\_user.logo.bin" file onto the formatted thumb drive
12. It is very important that this file and only this file is present on the USB thumb drive
13. With the audiometer turned off insert the thumb drive into any available USB port
14. Turn on the AD629 and push the Temp/Setup Button from the Tone test screen
15. Enter "Common Settings" using the Setup/Tests Button
16. For the question "Do you want to install" press the "Yes" button
17. After installation is completed, press the "Back" button to get to the testing screen



### 3.9 Diagnostic Suite

This section describes the data-transfer and hybrid mode (On-Line / PC-operated modes) supported by AD629.

#### 3.9.1 AD629 setup

The setup is similar to that described in the previous chapter for audiometric data transfer.

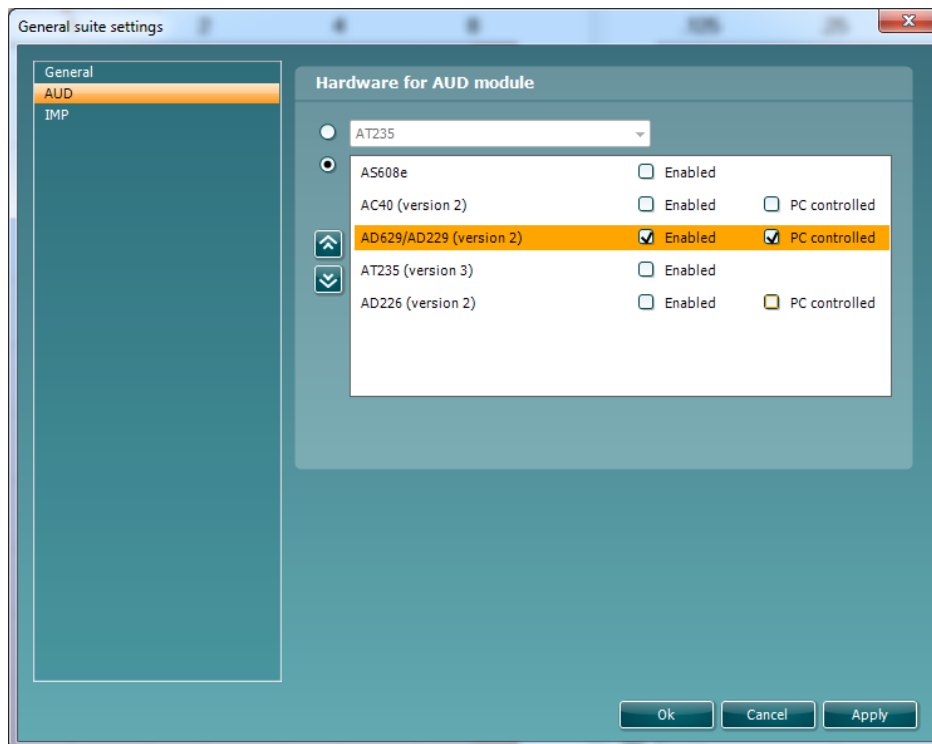
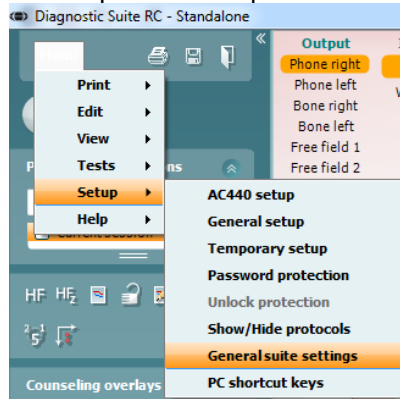

**Important:** Please be sure to select the “AD629 (version 2)” (and not “AD629”, which refers to the old version).

**PC controlled AD629:** Unselect this if you want to run the AD629 as a standalone audiometer (i.e. not as a hybrid audiometer) but still being connected to the Diagnostic Suite. When pressing *Save Session* on the AD629, the session will automatically be transferred to the Diagnostic Suite. See below section “Sync Mode.”





**Upload Print Logo and Audiogram Symbols to AD629:** A logo for direct print outs can be transferred to the AD629 using the “Up Print Logo” button. The symbol scheme used in the Diagnostic Suite can be transferred to the AD629 (when viewing the build in audiogram) by using the “Upload Custom Symbols” button. Please refer to the AD629 operational manual for info on how to change the symbol scheme on the AD629.

### 3.9.2 SYNC mode

#### One click data transfer (Hybrid Mode disabled)

If the “PC controlled AD629” setting in the General Setup (see above) is deselected, the current audiogram will be transferred to the Diagnostic Suite as follows: When pressing *Save Session* on the AD629, the session will automatically be transferred to the Diagnostic Suite Start the suite with device connected.

### 3.9.3 The SYNC tab

If several sessions are stored on the AD629 (under one or more patients), the Sync tab must be used. The screen shot below shows the Diagnostic Suite with the SYNC tab open (underneath the AUD and IMP tabs in the upper right corner).

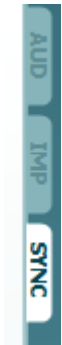

The SYNC tab provides the following possibilities:



**Client upload** is used for uploading clients from the database (Noah or OtoAccess) to the AD629. The internal AD629 memory can hold up to 1000 clients and 50.000 sessions (audiogram data).

**Session download** is used to download sessions (audiogram data) stored in the AD629 memory into to Noah, OtoAccess or XML (when running Diagnostic suite without a database).



### 3.9.4 Client upload

The following screen shot shows the client upload screen:

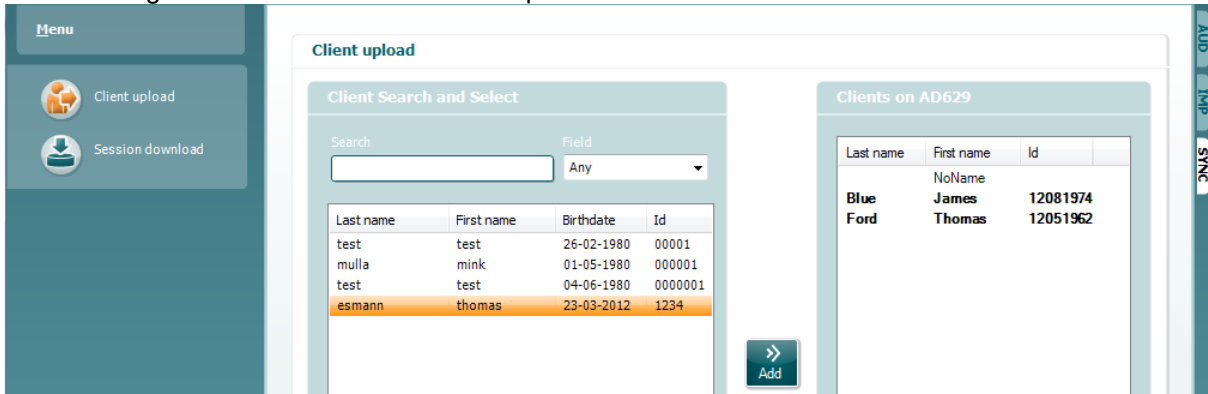

- On the left side it is possible to search for the client in the database to transfer to the database using different search criteria. Use the “Add” button to transfer (upload) the client from the database to the internal AD629 memory. The internal AD629 memory can hold up to 1000 clients and 50.000 sessions (audiogram data)
- On the right side the clients currently stored on the internal AD629 memory (hardware) is down. It is possible to remove all clients for individual clients using the “Remove all” or “Remove” buttons.

### 3.9.5 Session download

The following screen shot shows the session download screen:

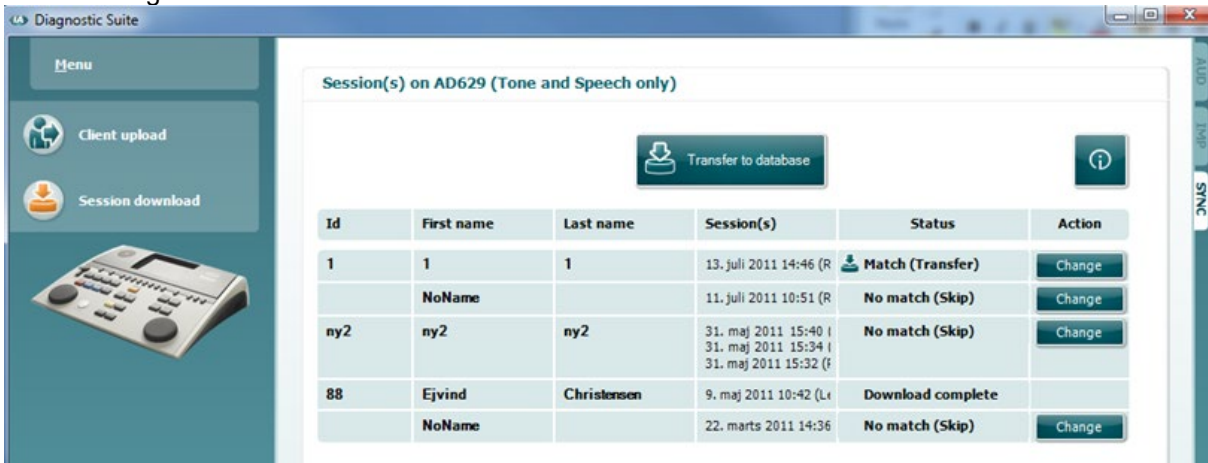



When pressing the  icon the functionality of the “Session download” screen is described:

Status	Meaning
 <b>Match (Transfer)</b>	This client on AC40 (version 2) was found (matched) in the database and the measurement will be transferred (downloaded) into the database after pressing 'Transfer to database'.
<b>No match (Skip)</b>	This client on AC40 (version 2) was not found (not matched) in the database and the measurement will not be transferred (downloaded) into the database after pressing 'Transfer to database'.
<b>Download complete</b>	The client measurement data stored on AC40 (version 2) was successfully transferred (downloaded) to the selected client in the database.

A client on the AC40 (version 2) can be transferred (downloaded) into a different (existing or new) client in the database by selecting "Change" under the "Action" column. This will open a new dialog for changing the client selection.



### 3.10 Hybrid (online/PC-controlled) mode

The following screen shots show the Diagnostic Suite AUD tab when running AD629 in “hybrid mode”.



This mode allows for the AD629 to be “on-line” connected to the PC – i.e. a true hybrid audiometer:

- Operate the unit via a PC and
- Operate the PC via the unit

The AC440 operational manual (found on [www.interacoustics.com/Equinox](http://www.interacoustics.com/Equinox)) explains in more detail how the AUD module works when running it in hybrid mode. Please note that the AC440 manual is covering the full clinical AC440 module for the Equinox and Affinity PC-based audiometers, so some features will not be present in the AD629 Diagnostic Suite AUD module.

The protocol settings of the Diagnostic Suite AUD module can be modified under the AC440 setup:

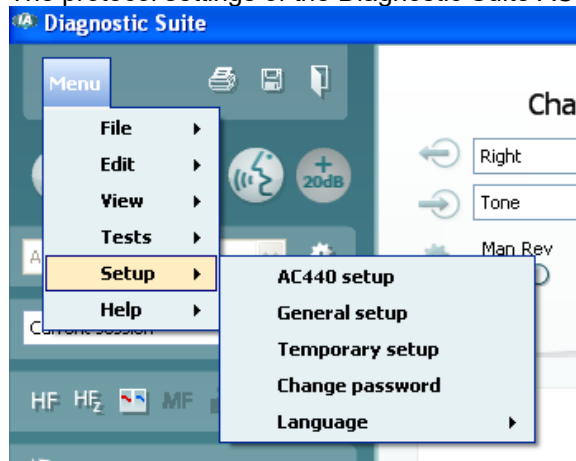



### 3.11 About Diagnostic Suite

Should you go to Menu > Help > About then you will see the below window. This is the area of the software where you can manage license keys and check your Suite, Firmware and Build Versions.



Also, in this window you will find the Checksum section which is a feature designed to help you identify the integrity of the software. It works by checking the file and folder content of your software version. This is using an SHA-256 algorithm.

On opening the checksum, you will see a string of characters and numbers, you can copy this by double clicking on it.



## 4 Maintenance

### 4.1 General maintenance procedures

It is recommended that routine check procedures are carried out weekly in full on all equipment in use. Check 1-9 outlined below should be followed on the equipment on each day of use.

The purpose of routine checking is to ensure that the equipment is working properly, that its calibration has not noticeably changed, and that its transducers and connections are free from any defect that might adversely affect the test result. The checking procedures should be carried out with the audiometer set up in its usual working situation. The most important elements in daily performance checks are the subjective tests and these tests can only be successfully carried out by an operator with unimpaired and preferably known good hearing. If a booth or separate test room is used, the equipment should be checked as installed; an assistant may be required in order to carry out the procedures. The checks will then cover the inter-connections between the audiometer and the equipment in the booth, and all connecting leads, plugs, and socket connections at the junction box (sound room wall) should be examined as potential sources of intermittency or incorrect connection. The ambient noise conditions during the tests should not be substantially worse than those encountered when the equipment is in use.

- 1) Clean and examine the audiometer and all accessories.
- 2) Check earphone cushions, plugs, main leads, and accessory leads for signs of wear or damage. Damaged or badly worn parts should be replaced.
- 3) Switch on equipment and leave for the recommended warm-up time. Carry out any set-up adjustments as specified. On battery-powered equipment, check battery state using the manufacturer's specified method. Switch on equipment and leave for the recommended warm-up time. If no warm-up period is quoted, allow 5 min for circuits to stabilize. Carry out any setting-up adjustments as specified. On battery-powered equipment, check battery state.
- 4) Check that earphone and bone vibrator serial numbers are correct for use with the audiometer.
- 5) Check that audiometer output is approximately correct on both air and bone conduction by conducting a simplified audiogram on a known test subject with known hearing; check for any change.
- 6) Check at high level (for example hearing levels of 60 dB on air conduction and 40 dB on bone conduction) on all appropriate functions (and on both earphones) at all frequencies used; listen for proper functioning, absence of distortion, freedom from clicks, etc.
- 7) Check all earphones (including masking transducer) and the bone vibrator for absence of distortion and intermittency; check plugs and leads for intermittency.
- 8) Check that all switch knobs are secure and that indicators work correctly.
- 9) Check that the subject's signal system operates correctly.
- 10) Listen at low levels for any sign of noise, hum, or unwanted sounds (break-through arising when a signal is introduced in another channel) or for any change in tone quality as masking is introduced.
- 11) Check that attenuators do attenuate the signals over their full range and that attenuators which are intended to be operated while a tone is being delivered are free from electrical or mechanical noise.
- 12) Check that controls operate silently and that no noise radiated from the audiometer is audible at the subject's position.
- 13) Check subject communication speech circuits, if appropriate, applying procedures similar to those used for pure-tone function.
- 14) Check tension of headset headband and bone vibrator headband. Ensure that swivel joints are free to return without being excessively slack.
- 15) Check headbands and swivel joints on noise-excluding headsets for signs of wear strain or metal fatigue.

The AD629 had been designed to provide many years of reliable service, but annual calibration is recommended due to possible impact on transducers.

We also required –recalibrating of the AD629; if something drastic happens to a part of it (e.g. headset or bone conductor is dropped on a hard surface).



Calibration procedure is available in service manual which is available on request.

## NOTICE

Great care should be exercised by the handling of earphones and other transducers, as mechanical shock may cause change of calibration.

### 4.2 How to clean Interacoustics products

If the surface of the AD629 or parts of it are contaminated, it can be cleaned using a soft cloth moistened with a mild solution of water and dish washing cleaner or similar. The use of organic solvents and aromatic oils must be avoided. Always disconnect the USB cable during the cleaning process and be careful that no fluid is entering the inside of the AD629 or the accessories.



- Before cleaning always switch off and disconnect from power
- Use a soft cloth lightly dampened with cleaning solution to clean all exposed surfaces
- Do not allow liquid to come in contact with the metal parts inside the earphones / headphones
- Do not autoclave, sterilize, or immerse the AD629 or accessory in any fluid
- Do not use hard or pointed objects to clean any part of the AD629 or accessory
- Do not let parts that have been in contact with fluids dry before cleaning
- Rubber ear-tips or foam ear-tips are single use components
- Ensure isopropyl alcohol does not come into contact with any screens on the AD629s

#### Recommended cleaning and disinfection solutions:

- Warm water with mild, nonabrasive cleaning solution (soap)
- 70% isopropyl alcohol

#### Procedure:

- Clean the AD629 by wiping outer case with a lint free cloth lightly dampened in cleaning solution
- Clean cushions and patient hand switch and other parts with a lint free cloth lightly dampened in cleaning solution
- Make sure not to get moisture in the speaker portion of the earphones and similar parts

### 4.3 Concerning repair

Interacoustics is only considered to be responsible for the validity of the CE marking, effects on safety, reliability, and performance of the equipment if:

1. assembly operations, extensions, readjustments, modifications, or repairs are carried out by authorised persons,
2. a 1 year service interval is maintained
3. the electrical installation of the relevant room complies with the appropriate requirements, and
4. the equipment is used by authorised personnel in accordance with the documentation supplied by Interacoustics.

The customer shall reach out to the local distributor to determine the service/repair possibilities including onsite service/repair. It is important that the customer (through local distributor) fills out the **RETURN REPORT** every time when the component/product is sent for service/repair to Interacoustics.



## 4.4 Warranty

Interacoustics warrants that:

- The AD629 is free from defects in material and workmanship under normal use and service for a period of 12 months from the date of delivery by Interacoustics to the first purchaser
- Accessories are free from defects in material and workmanship under normal use and service for a period of ninety (90) days from the date of delivery by Interacoustics to the first purchaser

If any product requires service during the applicable warranty period, please communicate directly with your local Interacoustics service centre to determine the appropriate repair facility. Repair or replacement will be carried out at Interacoustics' expense, subject to the terms of this warranty. The product requiring service should be returned promptly, properly packed, and postage prepaid. Loss or damage in return shipment to Interacoustics shall be at purchaser's risk.

In no event shall Interacoustics be liable for any incidental, indirect or consequential damages in connection with the purchase or use of any Interacoustics product.

This shall apply solely to the original purchaser. This warranty shall not apply to any subsequent owner or holder of the product. Furthermore, this warranty shall not apply to, and Interacoustics shall not be responsible for, any loss arising in connection with the purchase or use of any Interacoustics product that has been:

- repaired by anyone other than an authorized Interacoustics service representative;
- altered in any way so as, in Interacoustics judgement, to affect its stability or reliability;
- subject to misuse or negligence or accident, or which has had the serial or lot number altered, effaced, or removed; or
- improperly maintained or used in any manner other than in accordance with the instructions furnished by Interacoustics.

This warranty is in lieu of all other warranties, express or implied, and of all other obligations or liabilities of Interacoustics, and Interacoustics does not give or grant, directly or indirectly, the authority to any representative or other person to assume on behalf of Interacoustics any other liability in connection with the sale of Interacoustics products.

**INTERACOUSTICS DISCLAIMS ALL OTHER WARRANTIES, EXPRESSED OR IMPLIED, INCLUDING ANY WARRANTY OF MERCHANTABILITY OR FOR FUNCTION OF FITNESS FOR A PARTICULAR PURPOSE OR APPLICATION.**





## 5 General technical specifications

### 5.1 AD629 technical specification

<b>Medical CE-mark:</b>	The CE-mark in combination with MD symbol indicates that Interacoustics A/S meets the requirements of the Medical Device Regulation (EU) 2017/745 Annex I. Approval of the quality system is made by TÜV – identification no. 0123.	
<b>Standards:</b>	<b>Safety:</b>	IEC 60601-1 2005/EN 60601-1 2006 and A1 2012 ANSI/AAMI ES60601-1:2005/(R)2012 CAN/CSA-C22.2 No. 60601-1:14 Class II, Type B applied parts
	<b>EMC:</b>	IEC 60601-1-2 (2014)
	<b>Audiometer:</b>	Tone Audiometer: IEC 60645 -1 (2017), ANSI S3.6 (2010), Type 2 Speech Audiometer: IEC 60645-1 (2017)/ANSI S3.6 (2010) type B or B-E. Auto threshold tests: ISO 8253-1 (2010)
<b>Calibration</b>	Calibration information and instructions are located in the AD629 Service manual	
<b>Air Conduction</b>	DD45: TDH39: DD65 v2  IP 30:	PTB/DTU report 2009 ISO 389-1 1998, ANSI S3.6-2010 PTB 1.61-4091606 2018 & AAU 2018 ISO 389-2 1994, ANSI S3.6-2010 DES-2361
<b>Bone Conduction</b>	B71: Placement: Mastoid	ISO 389-3 1994, ANSI S3.6-2010
<b>Free Field</b>	ISO 389-7 2005, ANSI S3.6-2010	
<b>High Frequency</b>	ISO 389-5 2004, ANSI S3.6-2010	
<b>Effective masking</b>	ISO 389-4 1994, ANSI S3.6-2010	
<b>Transducers</b>	DD45 TDH39 DD450 DD65 v2 B71 Bone IP30	Headband Static Force 4.5N ±0.5N Headband Static Force 4.5N ±0.5N Headband Static Force 10N ±0.5N Headband Static Force 10N ±0.5N Headband Static Force 5.4N ±0.5N
<b>Patient Response switch</b>	One hand held push button.	
<b>Patient communication</b>	Talk Forward (TF) and Talk Back (TB).	
<b>Monitor</b>	Output through built-in speaker or through external earphone or speaker.	



<b>Special tests/test battery</b>	<p>SISI. ABLB. Stenger. Stenger Speech. Langenbeck (tone in noise). Békésy Test. Weber.</p> <p>2 channel speech, 2 channels Master Hearing Aid, Auto threshold.</p> <p>Auto threshold tests:</p> <p>Available time for patient to respond: Same as tone presentation</p> <p>Increment of hearing level: 5dB.</p> <p>Auto threshold test (Békésy):</p> <p>Mode of operation: Békésy</p> <p>Rate of level change: 2.5 dB/s ±20%</p> <p>Smallest increment of level: 0.5 dB</p>
<b>Stimuli</b>	
<b>Tone</b>	<p>125-20000Hz separated in two ranges 125-8000Hz and 8000-20000Hz.</p> <p>Resolution 1/2-1/24 octave.</p>
<b>Warble Tone</b>	<p>1-10 Hz sine +/- 5% modulation</p>
<b>Wave file</b>	<p>44100Hz sampling, 16 bits, 2 channels</p>
<b>Masking</b>	<p>Automatic selection of narrow band noise (or white noise) for tone presentation and speech noise for speech presentation.</p> <p>Narrow band noise: IEC 60645-1:2001, 5/12 Octave filter with the same centre frequency resolution as pure Tone.</p> <p>White noise: 80-20000Hz measured with constant bandwidth</p> <p>Speech Noise. IEC 60645-2:1993 125-6000Hz falling 12dB/octave above 1KHz +/-5dB</p>
<b>Presentation</b>	<p>Manual or Reverse. Single or multiple pulses.</p>
<b>Intensity</b>	<p>Check the accompanying Appendix</p> <p>Available Intensity Steps is 1, 2 or 5dB</p> <p>Extended range function: If not activated, the Air Conduction output will be limited to 20 dB below maximum output.</p>
<b>Frequency range</b>	<p>125Hz to 8kHz (Optional High Frequency: 8 kHz to 20 kHz)</p> <p>125Hz, 250Hz, 750Hz, 1500Hz and 8kHz may freely be deselected</p>



<p><b>Speech</b></p>	<p><b>Frequency Response:</b></p> <table border="1"> <thead> <tr> <th rowspan="2">(Typical)</th> <th rowspan="2">Frequency (Hz)</th> <th colspan="2">Linear (dB)</th> <th colspan="2">FFeq<sub>uv</sub> (dB)</th> </tr> <tr> <th>Ext sign<sup>1</sup> Sign<sup>2</sup></th> <th>Int.</th> <th>Ext sign<sup>1</sup> Sign<sup>2</sup></th> <th>Int.</th> </tr> </thead> <tbody> <tr> <td rowspan="3">TDH39 (IEC 60318-3 Coupler)</td> <td>125-250</td> <td>+0/-2</td> <td>+0/-2</td> <td>+0/-8</td> <td>+0/-8</td> </tr> <tr> <td>250-4000</td> <td>+2/-2</td> <td>+2/-1</td> <td>+2/-2</td> <td>+2/-2</td> </tr> <tr> <td>4000-6300</td> <td>+1/-0</td> <td>+1/-0</td> <td>+1/-0</td> <td>+1/-0</td> </tr> <tr> <td rowspan="3">DD65v2 (IEC 60645-1 Coupler)</td> <td>125-250</td> <td>+0/-2</td> <td>+1/-0</td> <td>+0/-</td> <td>+0/-7</td> </tr> <tr> <td>250-4000</td> <td>+1/-1</td> <td>+1/-1</td> <td>+2/-2</td> <td>+2/-3</td> </tr> <tr> <td>4000-6300</td> <td>+0/-2</td> <td>+0/-2</td> <td>+1/-1</td> <td>+1/-1</td> </tr> <tr> <td>IP 30 (IEC 60318-5 Coupler)</td> <td>250-4000</td> <td>+2/-3</td> <td>+4/-1</td> <td colspan="2">(Non linear)</td> </tr> <tr> <td>B71 Bone Conductor (IEC 60318-6 Coupler)</td> <td>250-4000</td> <td>+12/-12</td> <td>+12/-12</td> <td colspan="2">(Non linear)</td> </tr> </tbody> </table> <p>2% THD at 1000 Hz max output +9 dB (increasing at lower frequency) Level range: -10 to 50 dB HL</p> <p>1. Ext. sign: CD input                      2. Int. sign: Wave files</p>	(Typical)	Frequency (Hz)	Linear (dB)		FFeq <sub>uv</sub> (dB)		Ext sign <sup>1</sup> Sign <sup>2</sup>	Int.	Ext sign <sup>1</sup> Sign <sup>2</sup>	Int.	TDH39 (IEC 60318-3 Coupler)	125-250	+0/-2	+0/-2	+0/-8	+0/-8	250-4000	+2/-2	+2/-1	+2/-2	+2/-2	4000-6300	+1/-0	+1/-0	+1/-0	+1/-0	DD65v2 (IEC 60645-1 Coupler)	125-250	+0/-2	+1/-0	+0/-	+0/-7	250-4000	+1/-1	+1/-1	+2/-2	+2/-3	4000-6300	+0/-2	+0/-2	+1/-1	+1/-1	IP 30 (IEC 60318-5 Coupler)	250-4000	+2/-3	+4/-1	(Non linear)		B71 Bone Conductor (IEC 60318-6 Coupler)	250-4000	+12/-12	+12/-12	(Non linear)	
(Typical)	Frequency (Hz)			Linear (dB)		FFeq <sub>uv</sub> (dB)																																																	
		Ext sign <sup>1</sup> Sign <sup>2</sup>	Int.	Ext sign <sup>1</sup> Sign <sup>2</sup>	Int.																																																		
TDH39 (IEC 60318-3 Coupler)	125-250	+0/-2	+0/-2	+0/-8	+0/-8																																																		
	250-4000	+2/-2	+2/-1	+2/-2	+2/-2																																																		
	4000-6300	+1/-0	+1/-0	+1/-0	+1/-0																																																		
DD65v2 (IEC 60645-1 Coupler)	125-250	+0/-2	+1/-0	+0/-	+0/-7																																																		
	250-4000	+1/-1	+1/-1	+2/-2	+2/-3																																																		
	4000-6300	+0/-2	+0/-2	+1/-1	+1/-1																																																		
IP 30 (IEC 60318-5 Coupler)	250-4000	+2/-3	+4/-1	(Non linear)																																																			
B71 Bone Conductor (IEC 60318-6 Coupler)	250-4000	+12/-12	+12/-12	(Non linear)																																																			
<p><b>External signal</b></p>	<p>Speech replaying equipment connected to the CD input must have a signal-to-noise ratio of 45 dB or higher.</p> <p>The speech material used must include a calibration signal suitable for adjusting the input to 0 dBVU.</p>																																																						
<p><b>Free Field</b></p>	<p><u>Power amplifier and loudspeakers</u></p> <p>With an input of 7 V<sub>rms</sub> - Amplifier and loudspeakers must be able to create a Sound Pressure Level of 100 dB in a distance of 1 meter - and meet the following requirements:</p> <table border="1"> <thead> <tr> <th colspan="2">Frequency Response</th> <th colspan="2">Total Harmonic Distortion</th> </tr> </thead> <tbody> <tr> <td>125-250 Hz</td> <td>+0/-10 dB</td> <td>80 dB SPL</td> <td>&lt; 3%</td> </tr> <tr> <td>250-4000 Hz</td> <td>±3 dB</td> <td>100 dB SPL</td> <td>&lt; 10%</td> </tr> <tr> <td>4000-6300 Hz</td> <td>±5 dB</td> <td></td> <td></td> </tr> </tbody> </table>	Frequency Response		Total Harmonic Distortion		125-250 Hz	+0/-10 dB	80 dB SPL	< 3%	250-4000 Hz	±3 dB	100 dB SPL	< 10%	4000-6300 Hz	±5 dB																																								
Frequency Response		Total Harmonic Distortion																																																					
125-250 Hz	+0/-10 dB	80 dB SPL	< 3%																																																				
250-4000 Hz	±3 dB	100 dB SPL	< 10%																																																				
4000-6300 Hz	±5 dB																																																						
<p><b>Internal storage</b></p>	<p>1000 clients / 50.000 sessions</p>																																																						
<p><b>Signal Indicator(VU)</b></p>	<p>Time weighting: 300mS Dynamic range: 23dB Rectifier characteristics: RMS</p> <p>Selectable inputs are provided with an attenuator by which the level can be adjusted to the indicator reference position(0dB)</p>																																																						



<b>Data Connections (sockets)</b>	4 x USB A (compatible with USB 1.1 and later) 1 x USB B (compatible with USB 1.1 and later) 1 x LAN Ethernet	
<b>External devices (USB)</b>	Standard PC mouse and keyboard (for data entry) Supported printers: Standard PCL3 printers (HP, Epson, Canon)	
<b>Input Specifications</b>	TB	100uVrms at max. gain for 0dB reading Input impedance : 3.2KOhm
	Mic.2	100uVrms at max. gain for 0dB reading Input impedance : 3.2KOhm
	CD	7mVrms at max. gain for 0dB reading Input impedance : 47KOhm
	TF (side panel)	100uVrms at max. gain for 0dB reading Input impedance : 3.2KOhm
	TF (front panel)	100uVrms at max. gain for 0dB reading Input impedance : 3.2KOhm
	Wave files	Plays wave file from hard disk drive
<b>Output Specifications</b>	FF1 & 2	7Vrms at min. 2KOhm load 60-20000Hz -3dB
	Left & Right	7Vrms at 10 Ohms load 60-20000Hz -3dB
	Ins. Left & Right	7Vrms at 10 Ohms load 60-20000Hz -3dB
	Bone	7Vrms at 10 Ohms load 60-10000Hz -3dB
	Ins. Mask	7Vrms at 10 Ohms load 60-20000Hz -3dB
	Monitor(side panel)	2x 3Vrms at 32 Ohms / 1.5Vrms at 8 Ohms load 60-20000Hz -3dB
<b>Display</b>	5,7 inch high resolution color display 640x480 pixels	
<b>Compatible software</b>	Diagnostic Suite - Noah, OtoAccess and XML compatible	
<b>Dimensions (LxWxH)</b>	36.5 x 29.5 x 6.5 cm / 14.4 x 11.6 x 2.6 inches	
<b>Weight</b>	3.3kg/6.3lb	
<b>Power supply</b>	100-240 V~, 50-60Hz max 0.5A	
<b>Operation environment</b>	Temperature:	15-35°C
	Re. Humidity:	30-90% Non condensing



<b>Transport and storage</b>	Transport temperature: -20-50°C Storage temperature: 0-50°C Re. Humidity: 10-95% Non condensing
------------------------------	---



## 5.2 Survey of reference and max hearing level tone audiometer.

Pure Tone RETSPL							
Transducer	DD45	TDH39	DD65 v2	DD450	IP30	B71	B81
Impedance	10 Ω	10 Ω	10 Ω	40 Ω	10 Ω	10 Ω	12.5 Ω
Coupler	6ccm	6ccm	Artificial ear	Artificial ear	2ccm	Mastoid	Mastoid
	RETSPL	RETSPL	RETSPL	RETSPL	RETSPL	RETFL	RETFL
Tone 125 Hz	47.5	45	30.5	30.5	26		
Tone 160 Hz	40.5	37.5	25.5	26	22		
Tone 200 Hz	33.5	31.5	21.2	22	18		
Tone 250 Hz	27	25.5	17	18	14	67	67
Tone 315 Hz	22.5	20	14	15.5	12	64	64
Tone 400 Hz	17.5	15	10.5	13.5	9	61	61
Tone 500 Hz	13	11.5	8	11	5.5	58	58
Tone 630 Hz	9	8.5	6.5	8			
Tone 630 Hz			6.5	8	4	52.5	52.5
Tone 750 Hz	6.5	8 / 7.5	5.5	6	2	48.5	48.5
Tone 800 Hz	6.5	7	5	6	1.5	47	47
Tone 1000 Hz	6	7	4.5	5.5	0	42.5	42.5
Tone 1250 Hz	7	6.5	3.5	6	2	39	39
Tone 1500 Hz	8	6.5	2.5	5.5	2	36.5	36.5
Tone 1600 Hz	8	7	2.5	5.5	2	35.5	35.5
Tone 2000 Hz	8	9	2.5	4.5	3	31	31
Tone 2500 Hz	8	9.5	2	3	5	29.5	29.5
Tone 3000 Hz	8	10	2	2.5	3.5	30	30
Tone 3150 Hz	8	10	3	4	4	31	31
Tone 4000 Hz	9	9.5	9.5	9.5	5.5	35.5	35.5
Tone 5000 Hz	13	13	15.5	14	5	40	40
Tone 6000 Hz	20.5	15.5	21	17	2	40	40
Tone 6300 Hz	19	15	21	17.5	2	40	40
Tone 8000 Hz	12	13	21	17.5	0	40	40
Tone 9000 Hz				19			
Tone 10000 Hz				22			
Tone 11200 Hz				23			
Tone 12500 Hz				27.5			
Tone 14000 Hz				35			
Tone 16000 Hz				56			
Tone 18000 Hz				83			
Tone 20000 Hz				105			

DD45 6ccm uses IEC60318-3 or NBS 9A coupler and RETSPL comes from PTB – DTU report 2009-2010. Force 4.5N ±0.5N

TDH39 6ccm uses IEC60318-3 or NBS 9A coupler and RETSPL comes from ANSI S3.6 2010 and ISO 389-1 1998. Force 4.5N ±0.5N

DD450 uses IEC60318-1 and RETSPL comes from ANSI S3.6 – 2018, Force 10N ±0.5N.

IP30 / 2ccm uses ANSI S3.7-1995 IEC60318-5 coupler (HA-2 with 5mm rigid Tube) and RETSPL comes from ANSI S3.6 2010 and ISO 389-2 1994.

DD65 v2 Artificial ear uses IEC60318-1 coupler with type 1 adapter and RETSPL comes from ANSI S3.6 2018. Force 10 ±0.5N

B71 / B81 uses ANSI S3.13 or IEC60318-6 2007 mechanical coupler and RETFL come from ANSI S3.6 2010 and ISO 389-3 1994. Force 5.4N ±0.5N



## Pure Tone max HL

Transducer	DD45	TDH39	DD65 v2	DD450	IP30	B71	B81
Impedance	10 Ω	10 Ω	10 Ω	40 Ω	10 Ω	10 Ω	12.5 Ω
Coupler	6ccm	6ccm	Artificial ear	Artificial ear	2ccm	Mastoid	Mastoid
Signal	Max HL	Max HL	Max HL	Max HL	Max HL	Max HL	Max HL
Tone 125 Hz	90	90	85	100	90.0		
Tone 160 Hz	95	95	90	105	95		
Tone 200 Hz	100	100	95	105	100		
Tone 250 Hz	110	110	100	110	105	45	50
Tone 315 Hz	115	115	105	115	105	50	60
Tone 400 Hz	120	120	110	115	110	65	70
Tone 500 Hz	120	120	110	115	110	65	70
Tone 630 Hz	120	120	110	120	115	70	75
Tone 750 Hz	120	120	115	120	115	70	75
Tone 800 Hz	120	120	115	120	115	70	75
Tone 1000 Hz	120	120	115	120	120	70	85
Tone 1250 Hz	120	120	115	110	120	70	90
Tone 1500 Hz	120	120	115	115	120	70	90
Tone 1600 Hz	120	120	115	115	120	70	90
Tone 2000 Hz	120	120	115	115	120	75	90
Tone 2500 Hz	120	120	115	115	120	80	85
Tone 3000 Hz	120	120	115	115	120	80	85
Tone 3150 Hz	120	120	115	115	120	80	85
Tone 4000 Hz	120	120	110	115	115	80	85
Tone 5000 Hz	120	120	105	105	105	60	70
Tone 6000 Hz	115	120	100	105	100	50	60
Tone 6300 Hz	115	120	100	105	100	50	55
Tone 8000 Hz	110	110	95	105	95	50	50
Tone 9000 Hz				100			
Tone 10000 Hz				100			
Tone 11200 Hz				95			
Tone 12500 Hz				90			
Tone 14000 Hz				80			
Tone 16000 Hz				60			
Tone 18000 Hz				30			
Tone 20000 Hz				15			



NB noise effective masking level						
Transducer	DD45	TDH39	DD450	IP30	B71	B81
Impedance	10 Ω	10 Ω	40 Ω	10 Ω	10 Ω	12.5 Ω
Coupler	6ccm	6ccm	Artificial ear	2ccm	Mastoid	Mastoid
	EM	EM	EM	EM	EM	EM
NB 125 Hz	51.5	49	34.5	30.0		
NB 160 Hz	44.5	41.5	30	26		
NB 200 Hz	37.5	35.5	26	22		
NB 250 Hz	31	29.5	22	18	71	71
NB 315 Hz	26.5	24	19.5	16	68	68
NB 400 Hz	21.5	19	17.5	13	65	65
NB 500 Hz	17	15.5	15	9.5	62	62
NB 630 Hz	14	13.5	13	9	57.5	57.5
NB 750 Hz	11.5	12.5	11	7	53.5	53.5
NB 800 Hz	11.5	12	11	6.5	52	52
NB 1000 Hz	12	13	11.5	6	48.5	48.5
NB 1250 Hz	13	12.5	12	8	45	45
NB 1500 Hz	14	12.5	11.5	8	42.5	42.5
NB 1600 Hz	14	13	11.5	8	41.5	41.5
NB 2000 Hz	14	15	10.5	9	37	37
NB 2500 Hz	14	15.5	9	11	35.5	35.5
NB 3000 Hz	14	16	8.5	9.5	36	36
NB 3150 Hz	14	16	10	10	37	37
NB 4000 Hz	14	14.5	14.5	10.5	40.5	40.5
NB 5000 Hz	18	18	19	10	45	45
NB 6000 Hz	25.5	20.5	22	7	45	45
NB 6300 Hz	24	20	22.5	7	45	45
NB 8000 Hz	17	18	22.5	5	45	45
NB 9000 Hz			24			
NB 10000 Hz			27			
NB 11200 Hz			28			
NB 12500 Hz			32.5			
NB 14000 Hz			40			
NB 16000 Hz			61			
NB 18000 Hz			88			
NB 20000 Hz			110			
White noise	0	0	0	0	42.5	42.5
TEN noise	25	25		16		

Effective masking value is RETSPL / RETFL add 1/3 octave correction for Narrow-band noise from ANSI S3.6 2010 or ISO389-4 1994.





NB noise max HL							
Transducer	DD45	TDH39	DD65 v2	DD450	IP30	B71	B81
Impedance	10 Ω	10 Ω	10 Ω	40 Ω	10 Ω	10 Ω	12.5 Ω
Coupler	6ccm	6ccm	Artificial ear	Artificial ear	2ccm	Mastoid	Mastoid
	Max HL	Max HL	Max HL	Max HL	Max HL	Max HL	Max HL
NB 125 Hz	75	75	75	75	90.0		
NB 160 Hz	80	85	80	80	95		
NB 200 Hz	90	90	85	80	100		
NB 250 Hz	95	95	90	85	105	35	40
NB 315 Hz	100	100	95	90	105	40	50
NB 400 Hz	105	105	100	95	105	55	60
NB 500 Hz	110	110	100	95	110	55	60
NB 630 Hz	110	110	100	95	110	60	65
NB 750 Hz	110	110	105	100	110	60	65
NB 800 Hz	110	110	105	100	110	60	65
NB 1000 Hz	110	110	105	100	110	60	70
NB 1250 Hz	110	110	105	95	110	60	75
NB 1500 Hz	110	110	105	100	110	60	75
NB 1600 Hz	110	110	105	100	110	60	75
NB 2000 Hz	110	110	105	100	110	65	70
NB 2500 Hz	110	110	105	100	110	65	65
NB 3000 Hz	110	110	105	100	110	65	65
NB 3150 Hz	110	110	100	100	110	65	65
NB 4000 Hz	110	110	100	100	110	65	60
NB 5000 Hz	110	110	95	95	105	50	55
NB 6000 Hz	105	110	90	90	100	45	50
NB 6300 Hz	105	110	90	90	100	40	45
NB 8000 Hz	100	100	85	90	95	40	40
NB 9000 Hz				85			
NB 10000 Hz				85			
NB 11200 Hz				80			
NB 12500 Hz				75			
NB 14000 Hz				70			
NB 16000 Hz				50			
NB 18000 Hz				20			
NB 20000 Hz				0			
White noise	120	120	110	115	110	70	70
TEN noise	110	110			100		



ANSI speech RETSPL							
Transducer	DD45	TDH39	DD65 v2	DD450	IP30	B71	B81
Impedance	10 Ω	10 Ω	10 Ω	40 Ω	10 Ω	10 Ω	12.5 Ω
Coupler	6ccm	6ccm	Artificial ear	Artificial ear	2ccm	Mastoid	Mastoid
	RETSPL	RETSPL	RETSPL	RETSPL	RETSPL	RETFL	RETFL
Speech	18.5	19.5	17	19			
Speech Equ.FF.	18.5	15.5	16,5	18,5			
Speech Non-linear	6	7	4,5	5,5	12.5	55	55
Speech noise	18.5	19.5	17	19			
Speech noise Equ.FF.	18.5	15.5	16,5	18,5			
Speech noise Non-linear	6	7	4,5	5,5	12.5	55	55
White noise in speech	21	22	19,5	21,5	15	57.5	57.5

DD45 (G<sub>F</sub>-G<sub>C</sub>) PTB-DTU report 2009-2010.

TDH39 (G<sub>F</sub>-G<sub>C</sub>) ANSI S3.6 2010.

DD450 (GF-GC) ANSI S3.6 2018 and ISO 389-8 2004.

ANSI Speech level 12.5 dB + 1 kHz RETSPL ANSI S3.6 2010 (acoustical linear weighting)

ANSI Speech Equivalent free field level 12.5 dB + 1 kHz RETSPL – (G<sub>F</sub>-G<sub>C</sub>) from ANSI S3.6 2010(acoustical equivalent sensitivity weighting)

ANSI Speech Not linear level 1 kHz RETSPL ANSI S3.6 2010 (DD45-TDH39-) and IP30-CIR- B71-B81 12.5 dB + 1 kHz RETSPL ANSI S3.6 2010 (no weighting)

ANSI speech max HL							
Transducer	DD45	TDH39	DD65 v2	DD450	IP30	B71	B81
Impedance	10 Ω	10 Ω	10 Ω	40 Ω	10 Ω	10 Ω	12.5 Ω
Coupler	6ccm	6ccm	Artificial ear	Artificial ear	2ccm	Mastoid	Mastoid
	Max HL	Max HL	Max HL	Max HL	Max HL	Max HL	Max HL
Speech	110	110	100	90			
Speech Equ.FF.	100	105	95	85			
Speech Non-linear	120	120	110	110	110	60	60
Speech noise	100	100	95	85			
Speech noise Equ.FF.	100	100	90	80			
Speech noise Non-linear	115	115	105	105	110	50	50
White noise in speech	95	95	95	90	95	55	60



IEC speech RETSPL							
Transducer	DD45	TDH39	DD65 v2	DD450	IP30	B71	B81
Impedance	10 Ω	10 Ω	10 Ω	40 Ω	10 Ω	10 Ω	12.5 Ω
Coupler	6ccm	6ccm	Artificial ear	Artificial ear	2ccm	Mastoid	Mastoid
	RETSPL	RETSPL	RETSPL	RETSPL	RETSPL	RETFL	RETFL
Speech	20	20	20	20			
Speech Equ.FF.	3.5	0.5	1.5	3.5			
Speech Non-linear	6	7	4,5	5,5	20	55	55
Speech noise	20	20	20	20			
Speech noise Equ.FF.	3.5	0.5	1.5	3.5			
Speech noise Non-linear	6	7	4,5	5,5	20	55	55
White noise in speech	22.5	22.5	22,5	22,5	22.5	57.5	57.5

DD45 (G<sub>F</sub>-G<sub>C</sub>) PTB-DTU report 2009-2010.

TDH39 (G<sub>F</sub>-G<sub>C</sub>) IEC60645-2 1997.

DD450 (GF-GC) ANSI S3.6 2018 and ISO 389-8 2004.

IEC Speech level IEC60645-2 1997 (acoustical linear weighting)

IEC Speech Equivalent free field level (G<sub>F</sub>-G<sub>C</sub>) from IEC60645-2 1997 (acoustical equivalent sensitivity weighting)

IEC Speech Not linear level 1 kHz RETSPL (DD45-TDH50-HDA200-) and IP30 - B71- B81 IEC60645-2 1997 (no weighting)

IEC speech max HL							
Transducer	DD45	TDH39	DD65 v2	DD450	IP30	B71	B81
Impedance	10 Ω	10 Ω	10 Ω	40 Ω	10 Ω	10 Ω	12.5 Ω
Coupler	6ccm	6ccm	Artificial ear	Artificial ear	2ccm	Mastoid	Mastoid
	Max HL	Max HL	Max HL	Max HL	Max HL	Max HL	Max HL
Speech	110	110	95	90			
Speech Equ.FF.	115	120	110	100			
Speech Non-linear	120	120	110	110	100	60	60
Speech noise	100	100	90	85			
Speech noise Equ.FF.	115	115	100	95			
Speech noise Non-linear	115	115	105	105	90	50	50
White noise in speech	95	95	95	90	85	55	60



Sweden speech RETSPL							
Transducer	DD45	TDH39	DD65 v2	DD450	IP30	B71	B81
Impedance	10 Ω	10 Ω	10 Ω	40 Ω	10 Ω	10 Ω	12.5 Ω
Coupler	6ccm	6ccm	Artificial ear	Artificial ear	2ccm	Mastoid	Mastoid
	RETSPL	RETSPL	RETSPL	RETSPL	RETSPL	RETFL	RETFL
Speech	22	22	20	20			
Speech Equ.FF.	3,5	0,5	1,5	3,5			
Speech Non-linear	22	22	4,5	5,5	21	55	55
Speech noise	27	27	20	20			
Speech noise Equ.FF.	3,5	0,5	1,5	3,5			
Speech noise Non-linear	27	27	4,5	5,5	26	55	55
White noise in speech	22.5	22.5	22.5	22.5	22.5	57.5	57.5

DD45 (G<sub>F</sub>-G<sub>C</sub>) PTB-DTU report 2009-2010.

TDH39 (G<sub>F</sub>-G<sub>C</sub>) IEC60645-2 1997.

DD450 (GF-GC) ANSI S3.6 2018 and ISO 389-8 2004.

Sweden Speech level STAF 1996 and IEC60645-2 1997 (acoustical linear weighting)

Sweden Speech Equivalent free field level (G<sub>F</sub>-G<sub>C</sub>) from IEC60645-2 1997 (acoustical equivalent sensitivity weighting)

Sweden Speech Not linear level 1 kHz RETSPL (DD45-TDH39-) and IP30 – - B71- B81 STAF 1996 and IEC60645-2 1997 (no weighting)

Sweden speech max HL							
Transducer	DD45	TDH39	DD65 v2	DD450	IP30	B71	B81
Impedance	10 Ω	10 Ω	10 Ω	40 Ω	10 Ω	10 Ω	12.5 Ω
Coupler	6ccm	6ccm	Artificial ear	Artificial ear	2ccm	Mastoid	Mastoid
	Max HL	Max HL	Max HL	Max HL	Max HL	Max HL	Max HL
Speech	108	108	95	90			
Speech Equ.FF.	115	120	110	100			
Speech Non-linear	104	105	110	110	99	60	60
Speech noise	93	93	90	85			
Speech noise Equ.FF.	115	115	100	95			
Speech noise Non-linear	94	95	105	105	84	50	50
White noise in speech	95	95	95	90	85	55	60



Norway speech RETSPL							
Transducer	DD45	TDH39	DD65 v2	DD450	IP30	B71	B81
Impedance	10 Ω	10 Ω	10 Ω	40 Ω	10 Ω	10 Ω	12.5 Ω
Coupler	6ccm	6ccm	Artificial ear	Artificial ear	2ccm	Mastoid	Mastoid
	RETSPL	RETSPL	RETSPL	RETSPL	RETSPL	RETFL	RETFL
Speech	40	40	20	40			
Speech Equ.FF.	3.5	0.5	1.5	3.5			
Speech Non-linear	6	7	4.5	5.5	40	75	75
Speech noise	40	40	20	40			
Speech noise Equ.FF.	3.5	0.5	1.5	3.5			
Speech noise Non-linear	6	7	4.5	5.5	40	75	75
White noise in speech	22.5	22.5	22.5	22.5	22.5	57.5	57.5

DD45 (G<sub>F</sub>-G<sub>C</sub>) PTB-DTU report 2009-2010.

TDH39 (G<sub>F</sub>-G<sub>C</sub>) IEC60645-2 1997.

DD450 (GF-GC) ANSI S3.6 2018 and ISO 389-8 2004.

Norway Speech level IEC60645-2 1997+20dB (acoustical linear weighting)

Norway Speech Equivalent free field level (G<sub>F</sub>-G<sub>C</sub>) from IEC60645-2 1997 (acoustical equivalent sensitivity weighting)

Norway Speech Not linear level 1 kHz RETSPL (DD45-TDH39-) and IP30 -- B71- B81 IEC60645-2 1997 +20dB (no weighting)

Norway speech max HL							
Transducer	DD45	TDH39	DD65 v2	DD450	IP30	B71	B81
Impedance	10 Ω	10 Ω	10 Ω	40 Ω	10 Ω	10 Ω	12.5 Ω
Coupler	6ccm	6ccm	Artificial ear	Artificial ear	2ccm	Mastoid	Mastoid
	Max HL	Max HL	Max HL	Max HL	Max HL	Max HL	Max HL
Speech	90	90	95	70			
Speech Equ.FF.	115	120	110	100			
Speech Non-linear	120	120	110	110	80	40	40
Speech noise	80	80	90	65			
Speech noise Equ.FF.	115	115	100	95			
Speech noise Non-linear	115	115	105	105	70	30	30
White noise in speech	95	95	95	90	85	55	60



Free field						
ANSI S3.6-2010					Free Field max SPL	
ISO 389-7 2005					Free Field max HL is found by subtracting the selected RETSPL value	
Frequency	Binaural			Binaural to Monaural	Free Field Line	
	0°	45°	90°	correction	Tone	NB
Hz	RETSPL	RETSPL	RETSPL	RETSPL	Max SPL	Max SPL
	dB	dB	dB	dB	dB	dB
125	22	21.5	21	2	102	97
160	18	17	16.5	2	98	93
200	14.5	13.5	13	2	104.5	99.5
250	11.5	10.5	9.5	2	106.5	101.5
315	8.5	7	6	2	103.5	98.5
400	6	3.5	2.5	2	106	101
500	4.5	1.5	0	2	104.5	99.5
630	3	-0.5	-2	2	103	98
750	2.5	-1	-2.5	2	102.5	97.5
800	2	-1.5	-3	2	107	102
1000	2.5	-1.5	-3	2	102.5	97.5
1250	3.5	-0.5	-2.5	2	103.5	98.5
1500	2.5	-1	-2.5	2	102.5	97.5
1600	1.5	-2	-3	2	106.5	101.5
2000	-1.5	-4.5	-3.5	2	103.5	98.5
2500	-4	-7.5	-6	2	101	96
3000	-6	-11	-8.5	2	104	94
3150	-6	-11	-8	2	104	94
4000	-5.5	-9.5	-5	2	104.5	99.5
5000	-1.5	-7.5	-5.5	2	108.5	98.5
6000	4.5	-3	-5	2	104.5	99.5
6300	6	-1.5	-4	2	106	96
8000	12.5	7	4	2	92.5	87.5
WhiteNoise	0	-4	-5.5	2		100

ANSI free field							
ANSI S3.6-2010					Free Field max SPL		
					Free Field max HL is found by subtracting the selected RETSPL value		
	Binaural					Binaural to Monaural	Free Field Line
	0°	45°	90°	135°	180°	correction	
	RETSPL	RETSPL	RETSPL	RETSPL	RETSPL	RETSPL	Max SPL
Speech	15	11	9.5	10	13	2	100
Speech Noise	15	11	9.5	10	13	2	100
Speech WN	17.5	13.5	12	12.5	15.5	2	97.5

IEC free field							
ISO 389-7 2005					Free Field max SPL		
					Free Field max HL is found by subtracting the selected RETSPL value		
	Binaural					Binaural to Monaural	Free Field Line
	0°	45°	90°	135°	180°	correction	
	RETSPL	RETSPL	RETSPL	RETSPL	RETSPL	RETSPL	Max SPL
Speech	0	-4	-5.5	-5	-2	2	100
Speech Noise	0	-4	-5.5	-5	-2	2	100
Speech WN	2.5	-1.5	-3	-2.5	0.5	2	97.5



Sweden free field							
ISO 389-7 2005						Free Field max SPL	
						Free Field max HL is found by subtracting the selected RETSPL value	
	Binaural					Binaural to Monaural correction	Free Field Line
	0°	45°	90°	135°	180°		0° - 45° - 90°
	RETSPL	RETSPL	RETSPL	RETSPL	RETSPL	RETSPL	Max SPL
Speech	0	-4	-5.5	-5	-2	2	100
Speech WN	2.5	-1.5	-3	-2.5	0.5	2	97.5

Norway free field							
ISO 389-7 2005						Free Field max SPL	
						Free Field max HL is found by subtracting the selected RETSPL value	
	Binaural					Binaural to Monaural correction	Free Field Line
	0°	45°	90°	135°	180°		0° - 45° - 90°
	RETSPL	RETSPL	RETSPL	RETSPL	RETSPL	RETSPL	Max SPL
Speech	0	-4	-5.5	-5	-2	2	100
Speech Noise	0	-4	-5.5	-5	-2	2	100
Speech WN	2.5	-1.5	-3	-2.5	0.5	2	97.5

Equivalent free field		
Speech Audiometer		
	TDH39	DD45
	IEC60645-2 1997 ANSI S3.6-2010	PTB – DTU 2010
Coupler	IEC60318-3	IEC60318-3
Frequency	G <sub>F</sub> -G <sub>C</sub>	G <sub>F</sub> -G <sub>C</sub>
125	-17,5	-21.5
160	-14,5	-17.5
200	-12,0	-14.5
250	-9,5	-12.0
315	-6,5	-9.5
400	-3,5	-7.0
500	-5,0	-7.0
630	0,0	-6.5
750		
800	-0,5	-4.0
1000	-0,5	-3.5
1250	-1,0	-3.5
1500		
1600	-4,0	-7.0
2000	-6,0	-7.0
2500	-7,0	-9.5
3000		
3150	-10,5	-12.0
4000	-10,5	-8.0
5000	-11,0	-8.5
6000		
6300	-10,5	-9.0
8000	+1,5	-1.5



## Sound attenuation values for earphones

Frequency [Hz]	Attenuation	
	TDH39/DD45 with MX41/AR or PN 51 Cushion [dB]*	IP30 [dB]*
125	3	33
160	4	34
200	5	35
250	5	36
315	5	37
400	6	37
500	7	38
630	9	37
750	-	
800	11	37
1000	15	37
1250	18	35
1500	-	
1600	21	34
2000	26	33
2500	28	35
3000	-	
3150	31	37
4000	32	40
5000	29	41
6000	-	
6300	26	42
8000	24	43



\*ISO 8253-1 2010





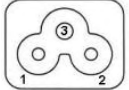
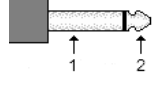
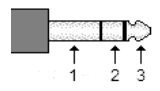
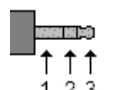
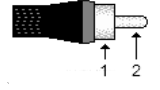

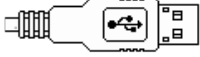
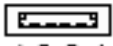
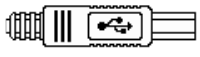
### 5.3 AD629 pin assignments

Socket	Connector	Pin 1	Pin 2	Pin 3
Mains	 IEC C6	Live	Neutral	Earth
Left & Right	 6.3mm Mono	Ground	Signal	-
Ins. Left & Right				
Bone				
Ins. Mask				
TB	 6.3mm Stereo	Ground	DC bias	Signal
Mic.2				
TF (front panel)				
Pat.Resp.				
CD	 3.5mm Stereo	Ground	CD2	CD1
TF (side panel)		Ground	DC bias	Signal
Monitor(side panel)		Ground	Right	Left
FF1 & FF2	 RCA	Ground	Signal	-

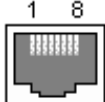
USB A (4 x Host)		USB B (Device)	
  4 3 2 1	1. +5 VDC	  1 2 4 3	1. +5 VDC
	2. Data -		2. Data -
	3. Data +		3. Data +
	4. Ground		4. Ground

LAN Ethernet		
 RJ45 Socket	 RJ45 Cable Plug	1. TX+ Transmit Data+
		1. TX- Transmit Data-
		2. RX+ Receive Data+
		3. Not connected
		4. Not connected
		5. RX- Receive Data-
		6. Not connected
7. Not connected		



## 5.4 Electromagnetic compatibility (EMC)

This equipment is suitable in hospital and clinical environments except for near-active HF surgical equipment and RF-shielded rooms of systems for magnetic resonance imaging, where the intensity of electromagnetic disturbance is high.

NOTICE: ESSENTIAL PERFORMANCE for this equipment is defined by the manufacturer as: This equipment does not have an ESSENTIAL PERFORMANCE Absence or loss of ESSENTIAL PERFORMANCE cannot lead to any unacceptable immediate risk. Final diagnosis shall always be based on clinical knowledge.

Use of this equipment adjacent to other equipment should be avoided because it could result in improper operation. If such use is necessary, this equipment and the other equipment should be observed to verify that they are operating normally.

Use of accessories and cables other than those specified or provided by the manufacturer of this equipment could result in increased electromagnetic emissions or decreased electromagnetic immunity of this equipment and result in improper operation. The list of accessories and cables can be found in this section.

Portable RF communications equipment (including peripherals such as antenna cables and external antennas) should be used no closer than 30 cm (12 inches) to any part of this equipment, including cables specified by the manufacturer. Otherwise, degradation of the performance of this equipment could result in improper operation.

This equipment complies with IEC60601-1-2:2014 emission class B group 1.

NOTICE: There are no deviations from the collateral standard and allowances uses.

NOTICE: All necessary instructions for maintenance comply with EMC and can be found in the general maintenance section in this instruction. No further steps required.

To ensure compliance with the EMC requirements as specified in IEC 60601-1-2, it is essential to use only the accessories specified in section 1.3

Anyone connecting additional equipment is responsible for making sure the system complies with the IEC 60601-1-2 standard.

Conformance to the EMC requirements as specified in IEC 60601-1-2 is ensured if the cable types and cable lengths are as specified below:

Description	Length (m)	Screened (Yes/No)
Monitor Headset w. microphone	2.9	Yes
Bone Conductors	2.0	No
Audiometric Headsets	2.0	Yes
Talk Back Microphone Clip-On	1.9	Yes
Free field speakers	0.6+0.9	Yes
Patient response switch	2.0	Yes
USB cable	1.9	Yes



### Guidance and manufacturer's declaration - electromagnetic emissions

The Instrument (AD629) is intended for use in the electromagnetic environment specified below. The customer or the user of the Instrument should assure that it is used in such an environment.

Emissions Test	Compliance	Electromagnetic environment - guidance
RF emissions CISPR 11	Group 1	The <b>Instrument</b> uses RF energy only for its internal function. Therefore, its RF emissions are very low and are not likely to cause any interference in nearby electronic equipment.
RF emissions CISPR 11	Class B	The <b>Instrument</b> is suitable for use in all commercial, industrial, business, and residential environments.
Harmonic emissions IEC 61000-3-2	Complies Class A Category	
Voltage fluctuations / flicker emissions IEC 61000-3-3	Complies	

### Recommended separation distances between portable and mobile RF communications equipment and the Instrument.

The **Instrument (AD629)** is intended for use in an electromagnetic environment in which radiated RF disturbances are controlled. The customer or the user of the **Instrument** can help prevent electromagnetic interferences by maintaining a minimum distance between portable and mobile RF communications equipment (transmitters) and the **Instrument** as recommended below, according to the maximum output power of the communications equipment.

Rated Maximum output power of transmitter [W]	Separation distance according to frequency of transmitter [m]		
	150 kHz to 80 MHz $d = 1.17\sqrt{P}$	80 MHz to 800 MHz $d = 1.17\sqrt{P}$	800 MHz to 2.7 GHz $d = 2.23\sqrt{P}$
0.01	0.12	0.12	0.23
0.1	0.37	0.37	0.74
1	1.17	1.17	2.33
10	3.70	3.70	7.37
100	11.70	11.70	23.30

For transmitters rated at a maximum output power not listed above, the recommended separation distance  $d$  in meters (m) can be estimated using the equation applicable to the frequency of the transmitter, where  $P$  is the maximum output power rating of the transmitter in watts (W) according to the transmitter manufacturer.

**Note 1** At 80 MHz and 800 MHz, the higher frequency range applies.

**Note 2** These guidelines may not apply to all situations. Electromagnetic propagation is affected by absorption and reflection from structures, objects and people.



### Guidance and Manufacturer's Declaration - Electromagnetic Immunity

The **Instrument (AD629)** is intended for use in the electromagnetic environment specified below. The customer or the user of the **Instrument** should assure that it is used in such an environment.

Immunity Test	IEC 60601 Test level	Compliance	Electromagnetic environment - guidance
Electrostatic Discharge (ESD) IEC 61000-4-2	+8 kV contact +15 kV air	+8 kV contact +15 kV air	Floors should be wood, concrete or ceramic tile. If floors are covered with synthetic material, the relative humidity should be greater than 30%.
Immunity to proximity fields from RF wireless communications equipment IEC 61000-4-3	Spot freq. 385-5.785 MHz Levels and modulation defined in table 9	As defined in table 9	RF wireless communications equipment should not be used close to any parts of the <b>Instrument</b> .
Electrical fast transient/burst IEC61000-4-4	+2 kV for power supply lines +1 kV for input/output lines	+2 kV for power supply lines +1 kV for input/output lines	Mains power quality should be that of a typical commercial or residential environment.
Surge IEC 61000-4-5	+1 kV Line to line +2 kV Line to earth	+1 kV Line to line +2 kV Line to earth	Mains power quality should be that of a typical commercial or residential environment.
Voltage dips, short interruptions and voltage variations on power supply lines IEC 61000-4-11	0% UT (100% dip in UT) for 0.5 cycle, @ 0, 45, 90, 135, 180, 225, 270 and 315° 0% UT (100% dip in UT) for 1 cycle 40% UT (60% dip in UT) for 5 cycles 70% UT (30% dip in UT) for 25 cycles 0% UT (100% dip in UT) for 250 cycles	0% UT (100% dip in UT) for 0.5 cycle, @ 0, 45, 90, 135, 180, 225, 270 and 315° 0% UT (100% dip in UT) for 1 cycle 40% UT (60% dip in UT) for 5 cycles 70% UT (30% dip in UT) for 25 cycles 0% UT (100% dip in UT) for 250 cycles	Mains power quality should be that of a typical commercial or residential environment. If the user of the <b>Instrument</b> requires continued operation during power mains interruptions, it is recommended that the <b>Instrument</b> be powered from an uninterruptable power supply or its battery.
Power frequency (50/60 Hz) IEC 61000-4-8	30 A/m	30 A/m	Power frequency magnetic fields should be at levels characteristic of a typical location in a typical commercial or residential environment.
Radiated fields in close proximity — Immunity test IEC 61000-4-39	9 kHz to 13.56 MHz. Frequency, level and modulation defined in AMD 1: 2020, table 11	As defined in table 11 of AMD 1: 2020	If the <b>Instrument</b> contains magnetically sensitive components or circuits, the proximity magnetic fields should be no higher than the test levels specified in Table 11

**Note:** UT is the A.C. mains voltage prior to application of the test level.



**Guidance and manufacturer's declaration — electromagnetic immunity**

The **Instrument (AD629)** is intended for use in the electromagnetic environment specified below. The customer or the user of the **Instrument** should assure that it is used in such an environment,

Immunity test	IEC / EN 60601 test level	Compliance level	Electromagnetic environment – guidance
Conducted RF IEC / EN 61000-4-6	3 Vrms 150kHz to 80 MHz	3 Vrms	Portable and mobile RF communications equipment should be used no closer to any parts of the <b>Instrument</b> , including cables, than the recommended separation distance calculated from the equation applicable to the frequency of the transmitter.  <b>Recommended separation distance:</b>  $d = \frac{3,5}{V_{rms}} \sqrt{P}$  $d = \frac{3,5}{v/m} \sqrt{P} \quad 80 \text{ MHz to } 800 \text{ MHz}$  $d = \frac{7}{v/m} \sqrt{P} \quad 800 \text{ MHz to } 2,7 \text{ GHz}$  Where $P$ is the maximum output power rating of the transmitter in watts (W) according to the transmitter manufacturer and $d$ is the recommended separation distance in meters (m).  Field strengths from fixed RF transmitters, as determined by an electromagnetic site survey, <sup>a</sup> should be less than the compliance level in each frequency range. <sup>b</sup>  Interference may occur in the vicinity of equipment marked with the following symbol:  
	6 Vrms In ISM bands (and amateur radio bands for Home Healthcare environment.)	6 Vrms	
Radiated RF IEC / EN 61000-4-3	3 V/m 80 MHz to 2,7 GHz	3 V/m	
	10 V/m 80 MHz to 2,7 GHz Only for Home Healthcare environment	10 V/m (If Home Healthcare)	

NOTE1 At 80 MHz and 800 MHz, the higher frequency range applies

NOTE 2 These guidelines may not apply in all situations. Electromagnetic propagation is affected by absorption and reflection from structures, objects and people.

<sup>a)</sup> Field strengths from fixed transmitters, such as base stations for radio (cellular/cordless) telephones and land mobile radios, amateur radio, AM and FM radio broadcast and TV broadcast cannot be predicted theoretically with accuracy. To assess the electromagnetic environment due to fixed RF transmitters, an electromagnetic site survey should be considered. If the measured field strength in the location in which the **Instrument** is used exceeds the applicable RF compliance level above, the **Instrument** should be observed to verify normal operation. If abnormal performance is observed, additional measures may be necessary, such as reorienting or relocating the **Instrument**.

<sup>b)</sup> Over the frequency range 150 kHz to 80 MHz, field strengths should be less than 3 V/m.

# Return Report – Form 001



Opr. dato: 2014-03-07 af: EC Rev. dato: af: MSt Rev. nr.: 4

Company: \_\_\_\_\_

Address: \_\_\_\_\_  
\_\_\_\_\_

Phone: \_\_\_\_\_

Fax or e-mail: \_\_\_\_\_

**Address**

10393 West 70<sup>th</sup> Street  
Prairie  
MN 55344  
USA

**Phone**

(+1) 800 947 6334

**Fax**

(+1) 952 903 4200

**E-mail**

rmd@interacoustics-us.com

Contact person: \_\_\_\_\_ Date: \_\_\_\_\_

**Following item is reported to be:**

- returned to INTERACOUSTICS for:  repair,  exchange,  other: \_\_\_\_\_
- defective as described below with request of assistance
- repaired locally as described below
- showing general problems as described below

**Item:** \_\_\_\_\_ **Type:** \_\_\_\_\_ **Quantity:** \_\_\_\_\_  
Serial No.: \_\_\_\_\_ Supplied by: \_\_\_\_\_  
Included parts: \_\_\_\_\_

**Important! - Accessories used together with the item must be included if returned (e.g. external power supply, headsets, transducers and couplers).**

**Description of problem or the performed local repair:**

\_\_\_\_\_  
\_\_\_\_\_  
\_\_\_\_\_

**Returned according to agreement with:**  Interacoustics,  Other : \_\_\_\_\_

Date : \_\_\_\_\_ Person : \_\_\_\_\_

Please provide e-mail address or fax No. to whom Interacoustics may confirm reception of the returned goods:

**The above mentioned item is reported to be dangerous to patient or user <sup>1</sup>**

In order to ensure instant and effective treatment of returned goods, it is important that this form is filled in and placed together with the item.  
Please note that the goods must be carefully packed, preferably in original packing, in order to avoid damage during transport. (Packing material may be ordered from Interacoustics)

<sup>1</sup> EC Medical Device Directive rules require immediate report to be sent, if the device by malfunction deterioration of performance or characteristics and/or by inadequacy in labelling or instructions for use, has caused or could have caused death or serious deterioration of health to patient or user. Page 1 of 1